

TX-29/25AD90F Service Manual

Safety

Specifications

Parts List

Service
Information

Adjustments

Self Check

Service Hints

Mechanical
View

Disassembly

Location of
Controls

Waveforms

Block Diagrams

Schematic Diagrams

PCB Views

Service Support

Service and repair of this product is supported by Panasonic's LUCI interface.

This interface provides a link between the TV and a standard PC to allow a number of diagnostic and control functions to be performed.

For more details contact your local Panasonic company.

BACK

EXIT

Audio

Control

Power supply

Video

BACK

D - PCB

E - PCBs

F - PCB

H - PCB

M - PCB

Y - PCB

BACK

D - Schematic

E - Schematic

F - Schematics

H - Schematic

M - Schematic

Y - Schematic

BACK

Service Manual



TELEVISORE A COLORI

TX-29AD90F
TX-25AD90F

Telaio EURO - 5

Specificazione

(I numeri tra parentesi { } si riferiscono al modello TX-25AD90F)

Alimentazione:	220-240V a.c., 50Hz
Consumo:	140W {130W}
Impedenza dell'antenna:	75Ω non bilanciata
Consumo in Stand-by:	1,9W
System di Ricezione:	CCIR 625 Linee PAL-I, B/G, H, D/K, PAL-525/60 SECAM L/L', B/G, D/K M.NTSC NTSC (Solo ingresso AV)
Canali Ricezione:	VHF E2-E12 VHF H1-H2 (ITALY) VHF A-H (ITALY) VHF R1-R2 VHF R3-R5 VHF R6-R12 UHF E21-E69 CATV (S01-S05) CATV S1-S10 (M1-M10) CATV S11-S20 (U1-U10) CATV S21-S41 (HYPER)
Frequenze Intermedie:	Video 38,9MHz, 34MHz Sound 32,9MHz, 33,4MHz, 33,16MHz 32,4MHz, 40,4MHz, 33,05MHz 32,66MHz Colore 34,47MHz (PAL) 34,5MHz, 34,65MHz (SECAM)
Prese Video/Audio:	USCITA AUDIO MONITOR Audio (RCAx2) 500mV rms 1kΩ INGRESSO AV1 Video (21 pin) 1V p-p 75Ω Audio (21 pin) 500mV rms 10kΩ RVB (21 pin)
USCITA AV1	Video (21 pin) 1V p-p 75Ω Audio (21 pin) 500mV rms 1kΩ

INGRESSO AV2	Video (21 pin) 1V p-p 75Ω Audio (21 pin) 500mV rms 10kΩ S-Video IN (21-pin) Y: 1V p-p 75Ω C: 0.3V p-p 75Ω
USCITA AV2	Video (21 pin) 1V p-p 75Ω Audio (21 pin) 500mV rms 1kΩ Uscita selezionabile (21 pin)
INGRESSO AV3	S-Video IN (4-pin) Y: 1V p-p 75Ω C: 0,3V p-p 75Ω Audio (RCAx2) 500mV rms 10kΩ Video (RCAx1) 1V p-p 75Ω

Tensione all'anodo: 30,2kV ±1kV

Tubo Catodico: A68EHM69X83 {A59ESF002X43}

Potenza Audio: 2 x 20W Sinistro/Destro
(Musicali) 8Ω Impedenza

Cuffia: 8Ω Impedenza

Accessori: Telecomando
2 x R6 (UM3) Batterie

Dimensioni:
Altezza: 570mm {510mm}
Larghezza: 698mm {625mm}
Profondità: 483mm {468mm}

Peso netto: 41kg {31kg}

Le caratteristiche possono variare senza preavviso.
Peso e dimensioni sono approssimate.

NOTA: Per maggiori informazioni consultare la guida tecnica del telaio EURO-5.

Panasonic

Indice

Norme di sicurezza.....	2
Consigli per l'assistenza.....	3
Posizione di Servizio.....	4
Procedura di taratura.....	5
Forma D'onda.....	6
Valori di allineamento.....	7
Schema a blocchi.....	8
Ubicazione Dei Componenti.....	12
Elenco Parti Di Ricambio.....	13
Schema Elettrico.....	28
Vista Lato Componenti.....	36

Norme di sicurezza

Precauzioni

1. E'Consigliabile utilizzare un trasformatore di isolamento prima di eseguire ogni intervento sul telaio.
2. Durante l'assistenza, verificare lo stato dei conduttori specialmente nei circuiti ad alta tensione. In caso di corto circuito, sostituire tutti le parti surriscaldate o danneggiate.
3. Dopo l'assistenza, assicurarsi che tutti gli accorgimenti di protezione (isolatori, schermi, isolatore R-C, ecc) siano correttamente installati.
4. Quando il televisore non viene utilizzato per lunghi periodi, scollegarlo dalla rete.
5. Alta tensione 31,2kV è presente quando il televisore é in funzione. Utilizzare il televisore senza il pannello posteriore comporta il pericolo di scosse elettriche dai circuiti di alimentazione. L'assistenza deve essere eseguita solo da personale specializzato a conoscenza delle necessarie precauzioni da adottare. Prima di intervenire sul cinescopio, scaricare a massa l'anodo dello stesso.
6. Dopo l'assistenza assicurarsi di eseguire le seguenti prove di dispersione per prevenire rischi di scossa elettrica all'utente.
4. Verificare ogni parte metallica esterna misurando la tensione ogni volta.
5. Invertire la presa a.c. di alimentazione e ripetere le misure precedenti.
6. Il potenziale in ogni punto non deve superare 1,4V rms, in caso superi questo valore, c'è pericolo di scossa elettrica e il televisore deve essere riparato e controllata prima di essere riconsegnato al proprietario.

Controllo a freddo di dispersione

1. Disinserire il cavo di alimentazione e corto circuitare i due terminali.
2. Azionare l'interruttore di accensione.
3. Collegare uno strumento per la misure di resistenza con segue un puntale sulla spina del cavo di alimentazione e l'altro sul telaio del televisore o su una parte metallica (ad esempio viti) collegate telaio. Se la parte metallica ha un collegamento col telaio la lettura dovrà essere compresa tra i valori 4MΩ e 20MΩ, se la parte metallica non ha un collegamento con il telaio la lettura dovrà essere.

Controllo a caldo di dispersione

1. Inserire la spina nella presa di corrente. Non usare un trasformatore di isolamento per questo controllo.
2. Collegare una resistenza da 2kΩ 10W in serie con una parte metallica esterna del televisore e con un punto di terra (esempio: tubi dell'acqua).
3. Utilizzare un voltmetro AC con sensibilità 1000Ω/Volt o più per misurare il potenziale ai capi della resistenza.

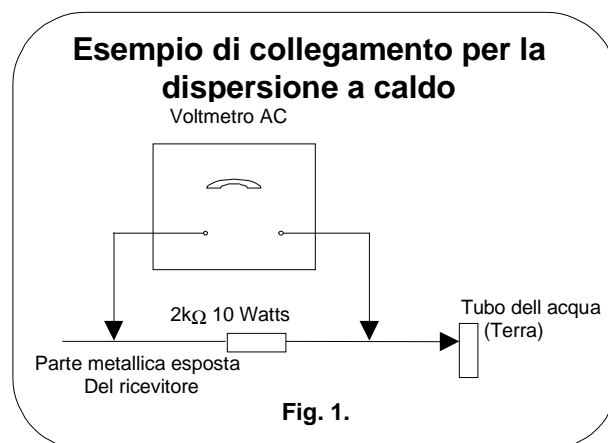

Radiazioni raggi X

Precauzioni:

1. La sezione ad alta tensione e il cinescopio sono sorgenti di raggi X.
2. In caso di utilizzo di una sonda per alta tensione, assicurarsi che la stessa sopporti 31,2kV senza pericolo di emissione di raggi.

NOTA: E'importante verificare periodicamente la funzionalità del misuratore di tensione.

1. Regolare la luminosità al minimo.
2. Misurare l'alta tensione. La lettura dovrà essere 30,2kV± 1kV. (se è necessario un immediato intervento tecnico per prevenire danni.)
3. Per prevenire la possibilità di emissione di raggi X, è indispensabile utilizzare il cinescopio specificato.

Consigli per l'assistenza

Come rimuovere il pannello posteriore

1. Rimuovere le 9 viti (A) come indicato in Fig.2.

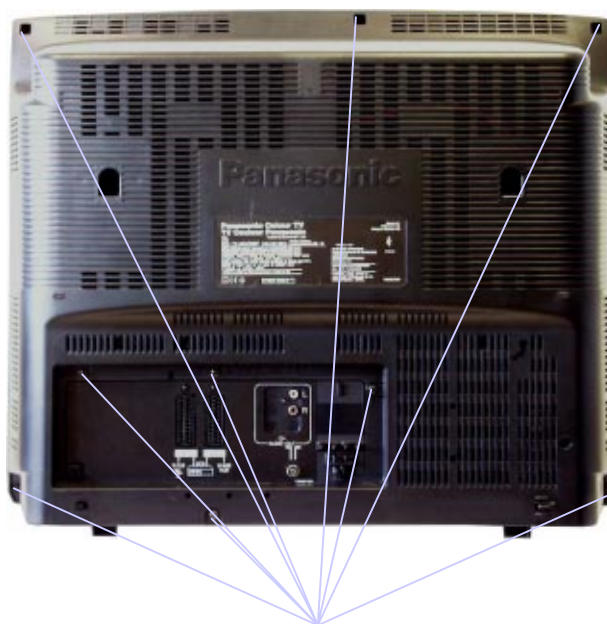

VITI (A)
Fig.2.

Ubicazione dei Controlli

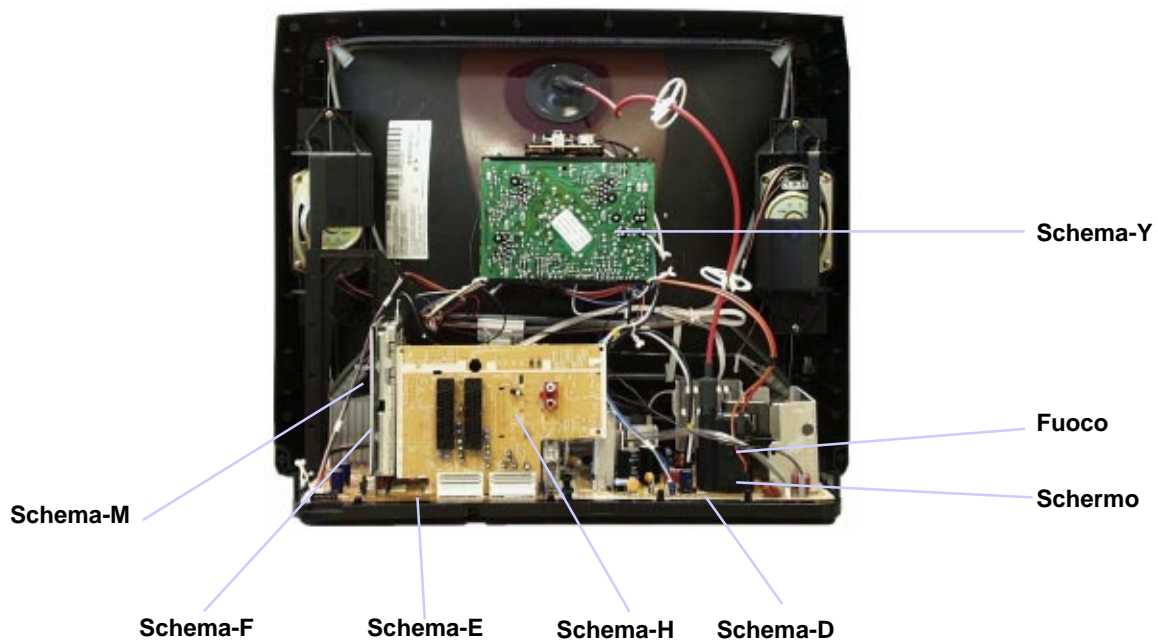
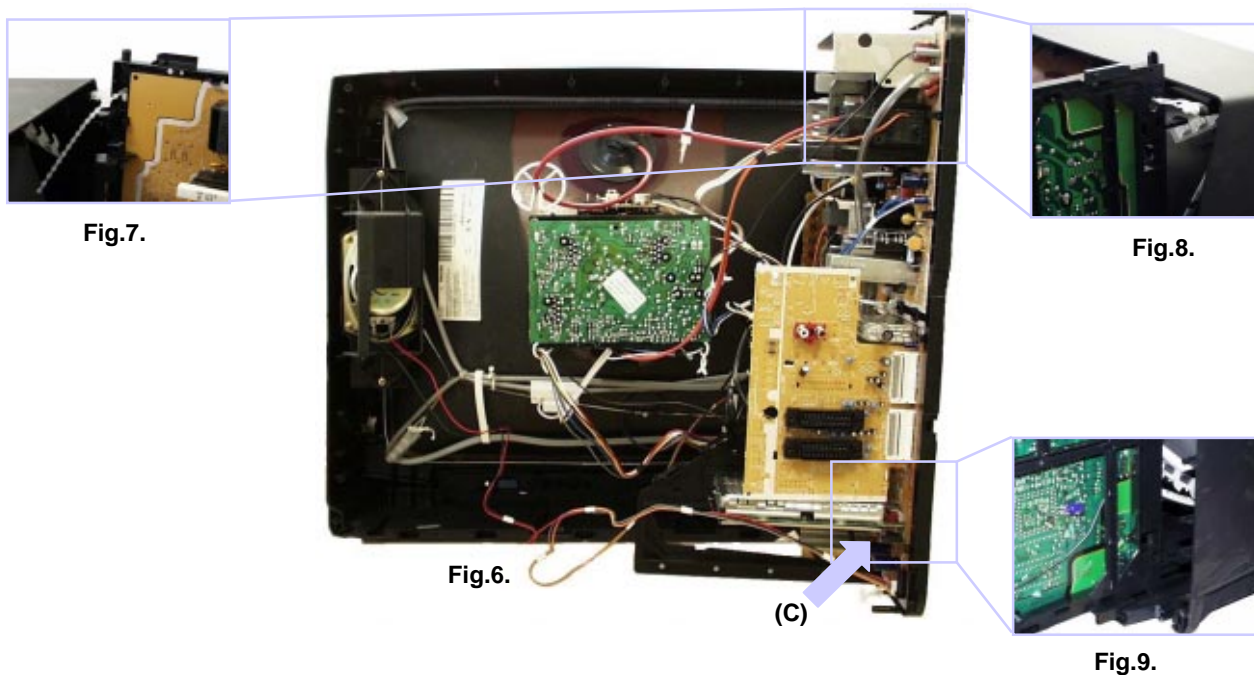
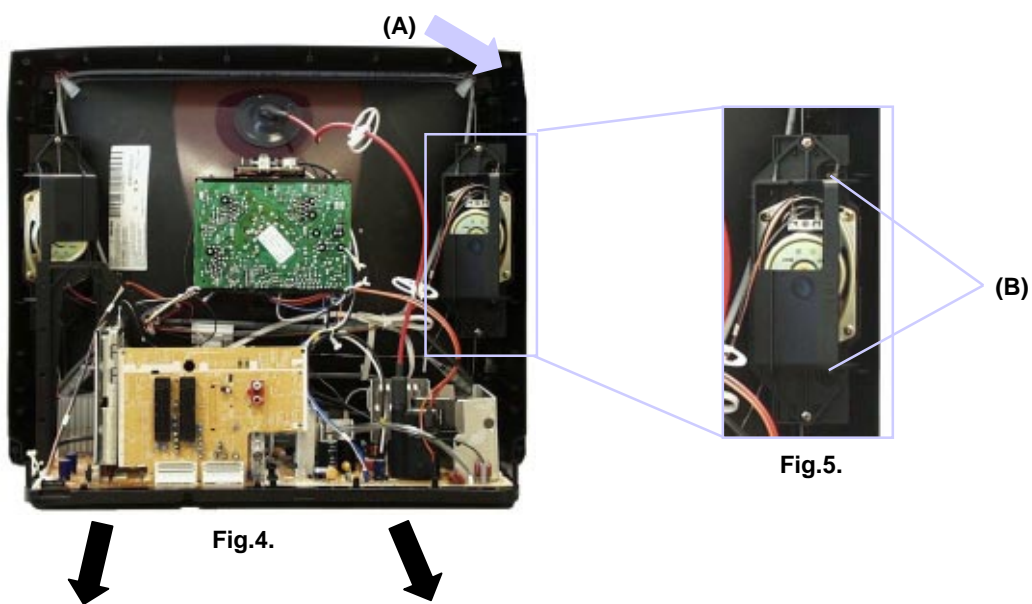

Fig.3.

Come predisporre il telaio nella Posizione di Servizio

1. Rimuovere il legaccio di plastica posto nel cavo di rete, ed avvitarlo nel punto **(A)** come illustrato in **fig.4** utilizzando una vite dello schienale.
2. Rimuovere le due viti **(B)**, e smontare l'altoparlante, vedi **fig.5**.
3. Spostare il telaio dal tv come in **fig.4**.
4. Rilasciare I fili dalle clip e ruotare verticalmente il telaio di 90° in senso anti-orario.
5. Sistemare la base del telaio nella sede **(C)**, come in **fig.6** e in **fig.8**.
6. Fissare il bordo del telaio utilizzando il legaccio plastica, vedi **fig.6** e **fig.7**.
7. Dopo la riparazione risistemare il telaio I fili e l'altoparlante nella posizione originale.



Procedura di taratura

TARATURE/PREPARAZIONE	REGOLAZIONE																																																				
REGOLAZIONE +B 1. Ricevere un segnale a barre colori. 2. Predisporre I controlli :- Luminosita' minimo Contrasto minimo Volume minimo	1. Confermare le seguenti alimentazioni <table border="0"> <thead> <tr> <th colspan="2">D-Board</th> <th colspan="2">E-Board</th> </tr> </thead> <tbody> <tr> <td>D3</td> <td>PIN5 147V ± 3V</td> <td>U8A</td> <td>E19-PIN8 8V ± 0,5V</td> </tr> <tr> <td>D12</td> <td>PIN5 5V ± 0,3V</td> <td>U9</td> <td>IC3801-PIN3 9V ± 0,5V</td> </tr> <tr> <td>D13</td> <td>PIN1 40V ± 4V</td> <td>U12</td> <td>E22-PIN8 12V ± 0,5V</td> </tr> <tr> <td>D3</td> <td>PIN4 230V ± 10V</td> <td>STD5V</td> <td>E26-PIN4 5V ± 0,5V</td> </tr> <tr> <td>D3</td> <td>PIN4 205V ± 10V</td> <td>U15</td> <td>E23-PIN8 15V ± 1V</td> </tr> <tr> <td>D3</td> <td>PIN4 190V ± 10V</td> <td>U15</td> <td>E23-PIN9 -15V ± 1V</td> </tr> <tr> <td>D3</td> <td>PIN4 190V ± 10V</td> <td>U33</td> <td>E22-PIN10 33V ± 4V</td> </tr> <tr> <td>D14</td> <td>PIN5 5V ± 0,5V</td> <td>U40</td> <td>E24-PIN1 40V ± 3V</td> </tr> <tr> <td>D12</td> <td>PIN7 15V ± 2V</td> <td>U5B</td> <td>E19-PIN5 5V ± 0,5V</td> </tr> <tr> <td>D12</td> <td>PIN9 15V ± 2V</td> <td></td> <td></td> </tr> <tr> <td>D11</td> <td>PIN8 12V ± 2V</td> <td></td> <td></td> </tr> <tr> <td>D11</td> <td>PIN10 33V ± 3V</td> <td></td> <td></td> </tr> </tbody> </table>	D-Board		E-Board		D3	PIN5 147V ± 3V	U8A	E19-PIN8 8V ± 0,5V	D12	PIN5 5V ± 0,3V	U9	IC3801-PIN3 9V ± 0,5V	D13	PIN1 40V ± 4V	U12	E22-PIN8 12V ± 0,5V	D3	PIN4 230V ± 10V	STD5V	E26-PIN4 5V ± 0,5V	D3	PIN4 205V ± 10V	U15	E23-PIN8 15V ± 1V	D3	PIN4 190V ± 10V	U15	E23-PIN9 -15V ± 1V	D3	PIN4 190V ± 10V	U33	E22-PIN10 33V ± 4V	D14	PIN5 5V ± 0,5V	U40	E24-PIN1 40V ± 3V	D12	PIN7 15V ± 2V	U5B	E19-PIN5 5V ± 0,5V	D12	PIN9 15V ± 2V			D11	PIN8 12V ± 2V			D11	PIN10 33V ± 3V		
D-Board		E-Board																																																			
D3	PIN5 147V ± 3V	U8A	E19-PIN8 8V ± 0,5V																																																		
D12	PIN5 5V ± 0,3V	U9	IC3801-PIN3 9V ± 0,5V																																																		
D13	PIN1 40V ± 4V	U12	E22-PIN8 12V ± 0,5V																																																		
D3	PIN4 230V ± 10V	STD5V	E26-PIN4 5V ± 0,5V																																																		
D3	PIN4 205V ± 10V	U15	E23-PIN8 15V ± 1V																																																		
D3	PIN4 190V ± 10V	U15	E23-PIN9 -15V ± 1V																																																		
D3	PIN4 190V ± 10V	U33	E22-PIN10 33V ± 4V																																																		
D14	PIN5 5V ± 0,5V	U40	E24-PIN1 40V ± 3V																																																		
D12	PIN7 15V ± 2V	U5B	E19-PIN5 5V ± 0,5V																																																		
D12	PIN9 15V ± 2V																																																				
D11	PIN8 12V ± 2V																																																				
D11	PIN10 33V ± 3V																																																				
CUT OFF 1. Ricevere un segnale a barre colori. 2. Smagnetizzare il cinescopio esternamente. 3. Entrare nel SERVICE Mode 1. 4. Selezionare CUT-OFF.	Regolare la VR per visualizzare O.K.																																																				

SELF CHECK (auto diagnosi)

Il SELF CHECK é usato per testare le linee "BUS" ed il codice esadecimale del TV. Per richiamare il SELF-CHECK occorre premere il tasto di "STATUS" sul telecomando e contemporaneamente il tasto (-) sul TV. Attenzione: quando si richiama il Self-check, il TV verrà resettato ritornando alle condizioni di fabbrica, cancellando I canali sintonizzati dal cliente. Sullo schermo apparirà la seguente in tabella :

VPC	O.K.	PCB	O.K.
TUN	O.K.		
E2	O.K.	Cab	O.K.
DPL	--	Sum	Solo per la fabbrica
CIP1	O.K.		
CIP2	O.K.		
VP	O.K.		
DFU	O.K.		
COL	--		
PIP	--		
DIS	O.K.		
OPTION 1	B9		
OPTION 2	1C		
OPTION 3	1F		
OPTION 4	00		
OPTION 5	FB		
OPTION 6	23		

Se uno degli ingressi/uscite della "CPU" e' riconosciuta come incorretta, sullo schermo apparira' "--" invece di "OK".

Materiale di supporto per l'assistenza TV.

- **LUCI** interface kit (Linked Utility Computer Interface)
Il kit contiene l'interfaccia, I cavi per la connessione al TV e al PC, il software per il diagnostico.
Ogni volta che verrà introdotta una nuova gamma di modelli sarà disponibile il nuovo software aggiornato.
- **VICI** (Visual Interactive Computer Information)
Questi C.D. rom contengono le seguenti informazioni:
 1. Service Manual
 2. Libretti di istruzioni (anche in lingua italiana)
 3. Informazioni tecniche
- **TASMIN** (Technically Advanced System for Multimedia Interactive Notes)
Rappresenta il primo passo per avere informazioni tecniche più velocemente ed in modo interattivo.

NOTA: Questo TV ha l'opzione per utilizzare la "Memory Pack", che vi permette di trasferire I canali sintonizzati nel TV e viceversa. La "Memory Pack" si puo' utilizzare solo con il telaio "EURO-5".

FORMA D'ONDA

NOTA: Tutte le forme d'onda sono state prese usando un segnale a barre colori standard.

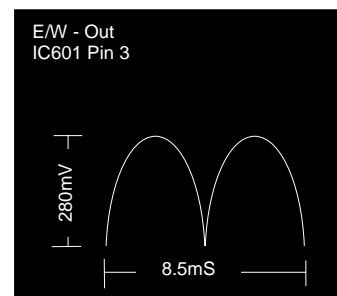
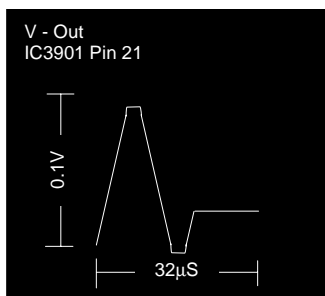
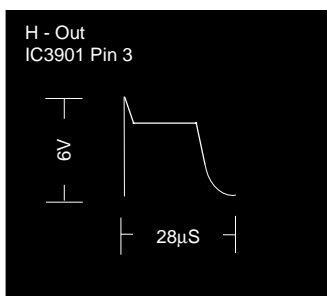
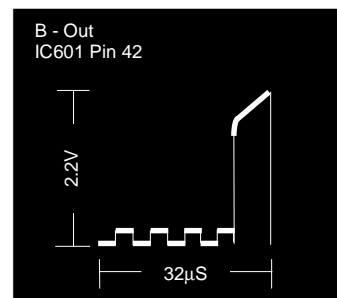
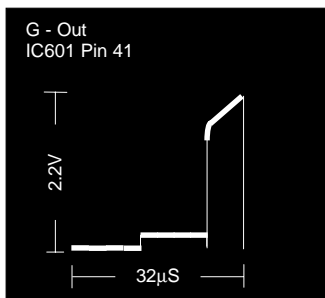
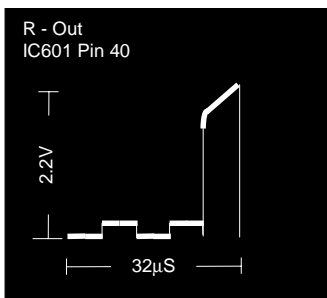
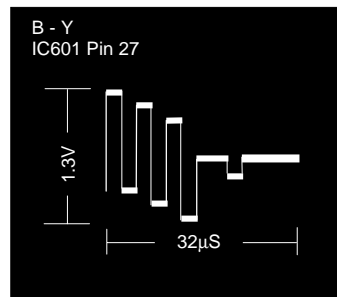
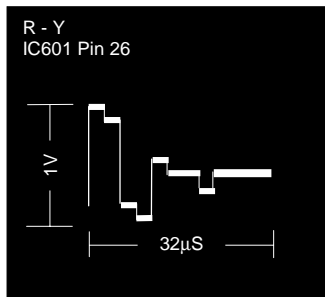
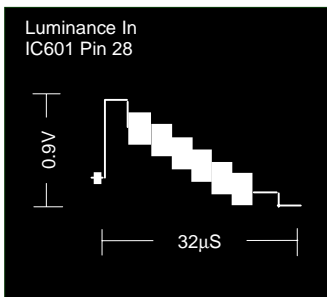
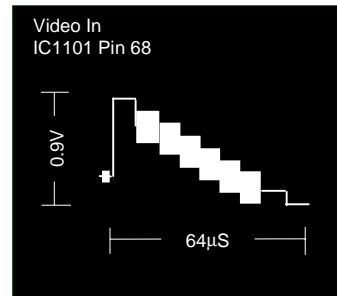
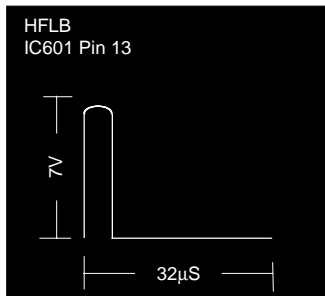
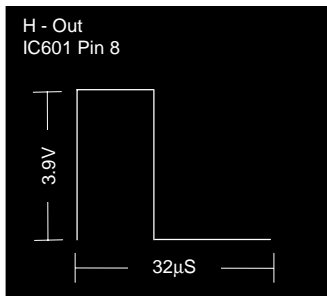
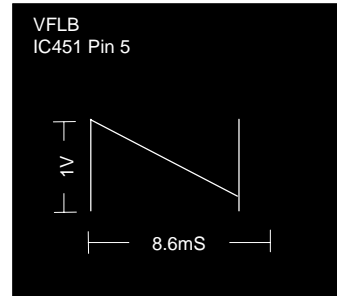
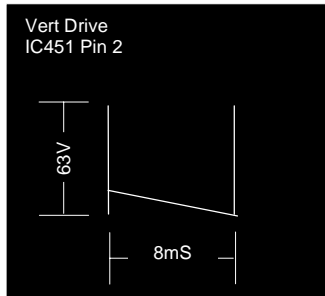
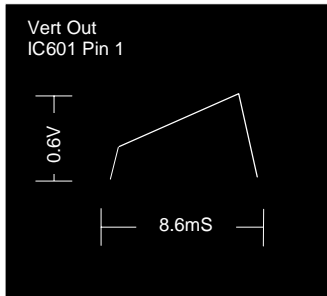

Valori di allineamento, esempi:

(N.B. I valori indicati sullo schermo sono approssimative.)

1. Regolare I toni bassi nella massima posizione, regolare I toni alti nella minima posizione, premere il tasto volume meno sulla tastiera del TV, e nello stesso tempo premere il tasto "**INDEX**" sul telecomando.
2. Premere I tasti **ROSSO** o **VERDE** per selezionare le Funzioni.
3. Premere I tasti **GIALLO** o **BLU** per modificare I valori.
4. Premere I tasto "**STR**" sulla tastiera del TV per memorizzare la regolazione eseguita.
5. Per uscire dal service mode occorre premere il tasto "**N**" sul telecomando.

Funzione	Valori indicativi	Impostazioni
Posizione orizz	H-Pos +020	Posizione ottimale.
V-Pos	V-Pos +024	Posizione ottimale.
Ampiezza orizz	H-Amp +049	Posizione ottimale.
Ampiezza vert	V-Amp +029	Posizione ottimale.
EO-ampiezza	EW-Amp 1 +022	Posizione ottimale.
EO-ampiezza	EW-Amp 2 +000	Posizione ottimale.
Correz-trapezoidale	Trapez-1 +033	Posizione ottimale.
Orizz-Parallel	H-Parallel +032	Posizione ottimale.
Linearita vert	V-Lin +004	Posizione ottimale.
DVCO	DVCO 000	Premere il tasto blu , poi STR .
Cutoff DC	Cut-off O.K.	Per regolare il cutoff collegare la sonda sul blu, e regolare con il tasto giallo o blu per 160V, premere STR . Selezionare Ug2 e regolare la VR per visualizzare ok.
Highlight	High 0031 0031 0031	Contrast Maximum A.I. Off Posizione ottimale.
Sub-Brightness	Sub-Brightness 000	Posizione ottimale.

SCHEMA A BLOCCHI SEGNALI VIDEO

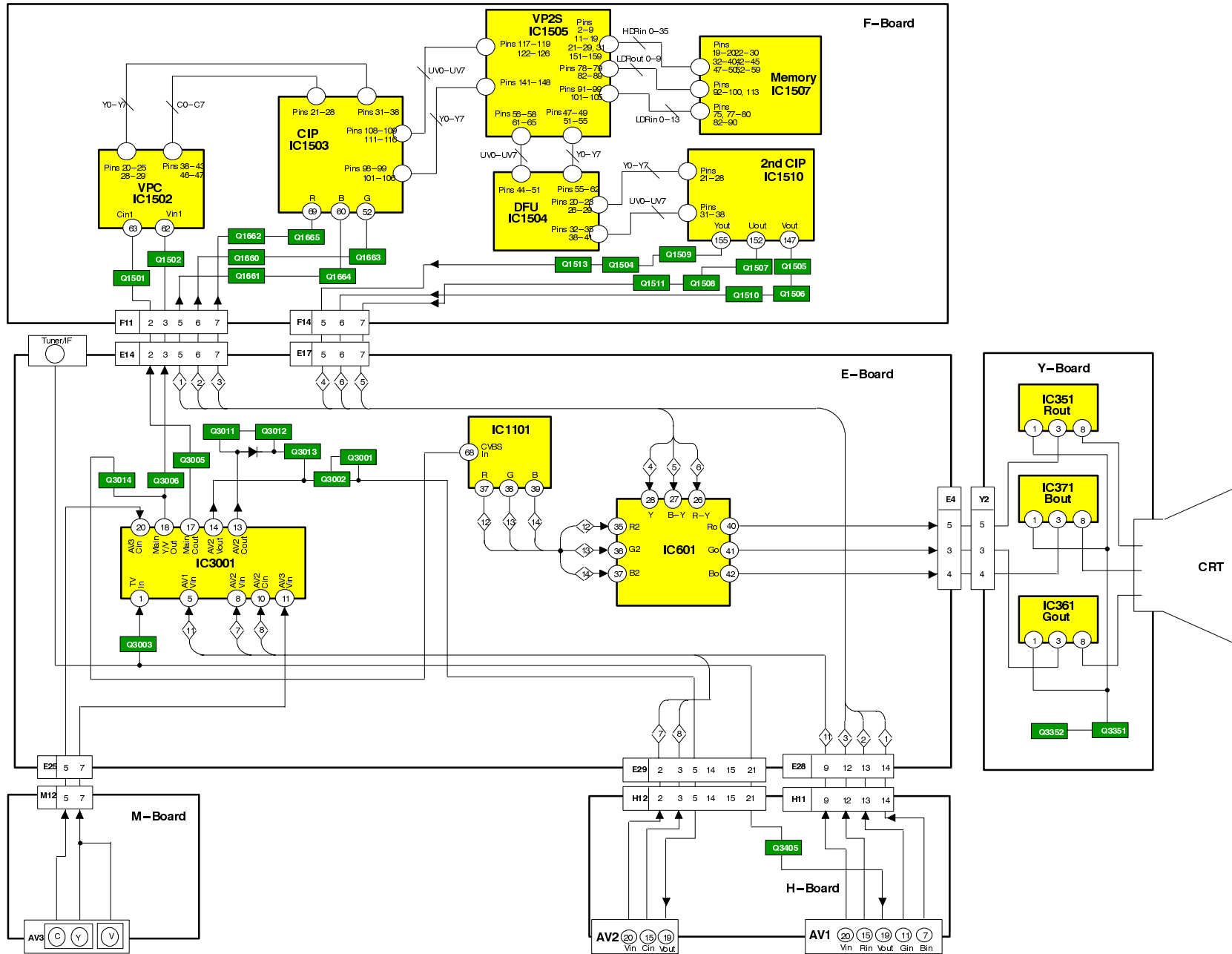

SCHEMA A BLOCCHI SEGNALI AUDIO

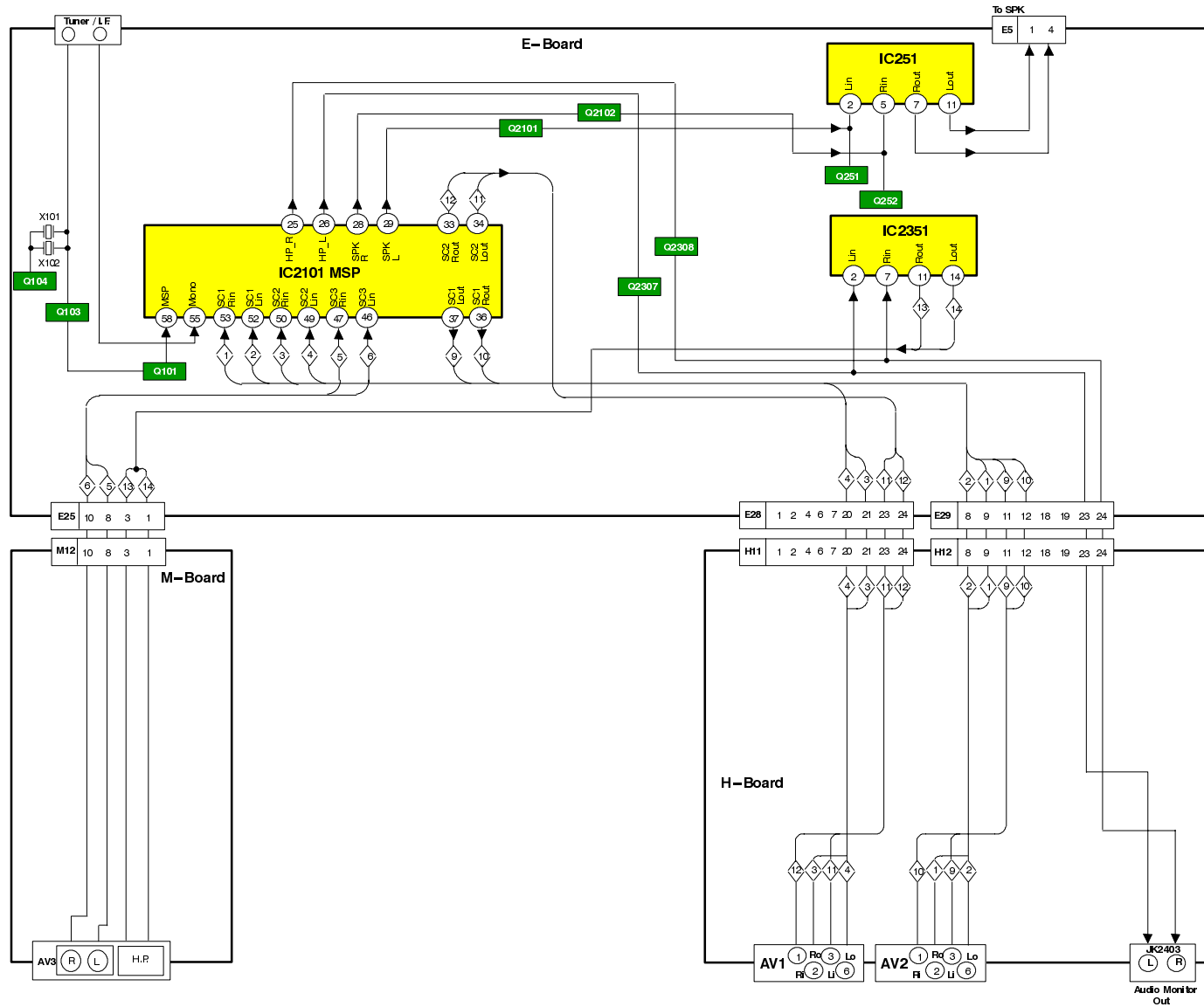

SCHEMA A BLOCCHI LINEE DI CONTROLLO

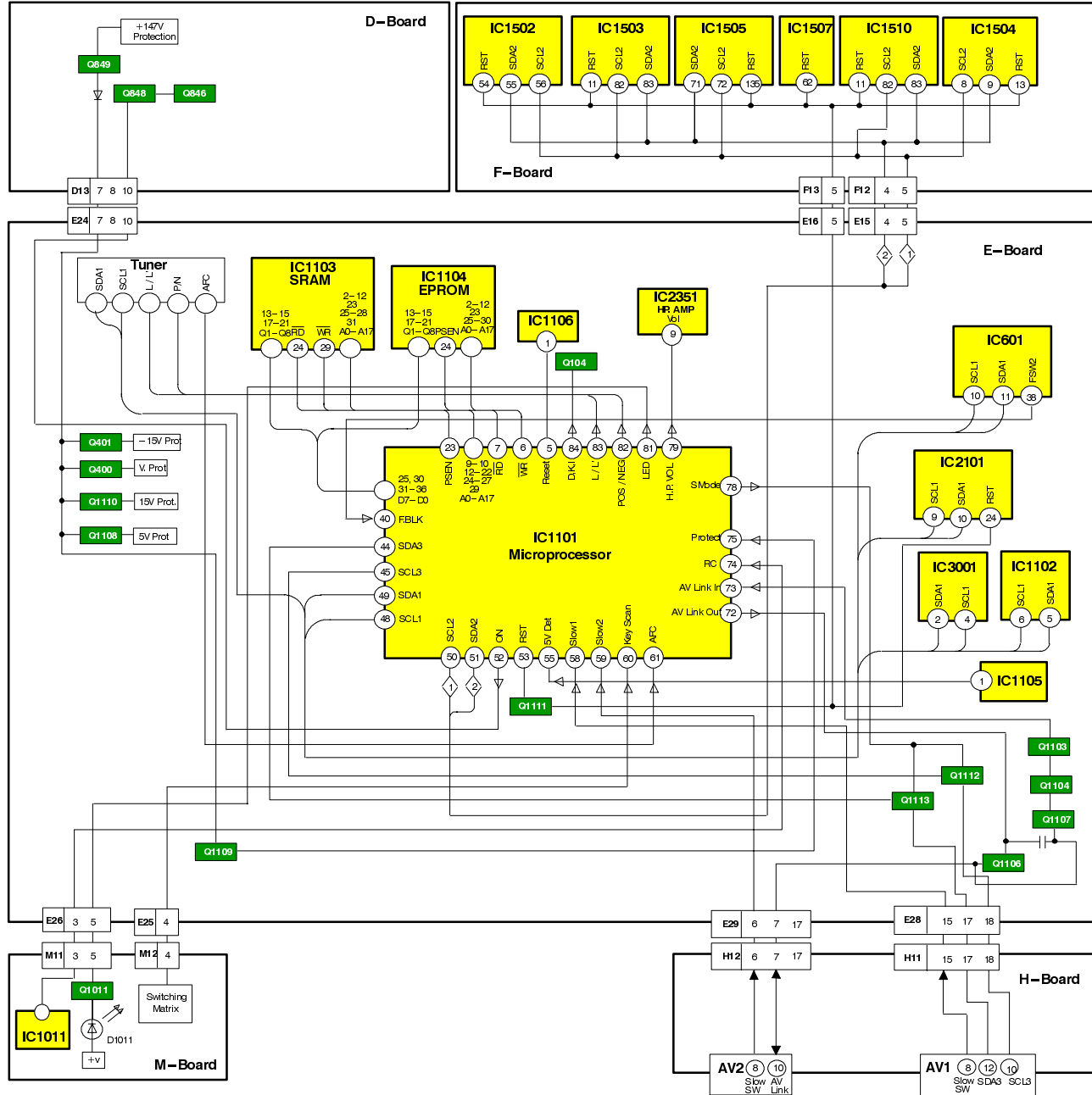

SCHEMA A BLOCCHI POTENZA ALIMENTAZIONE

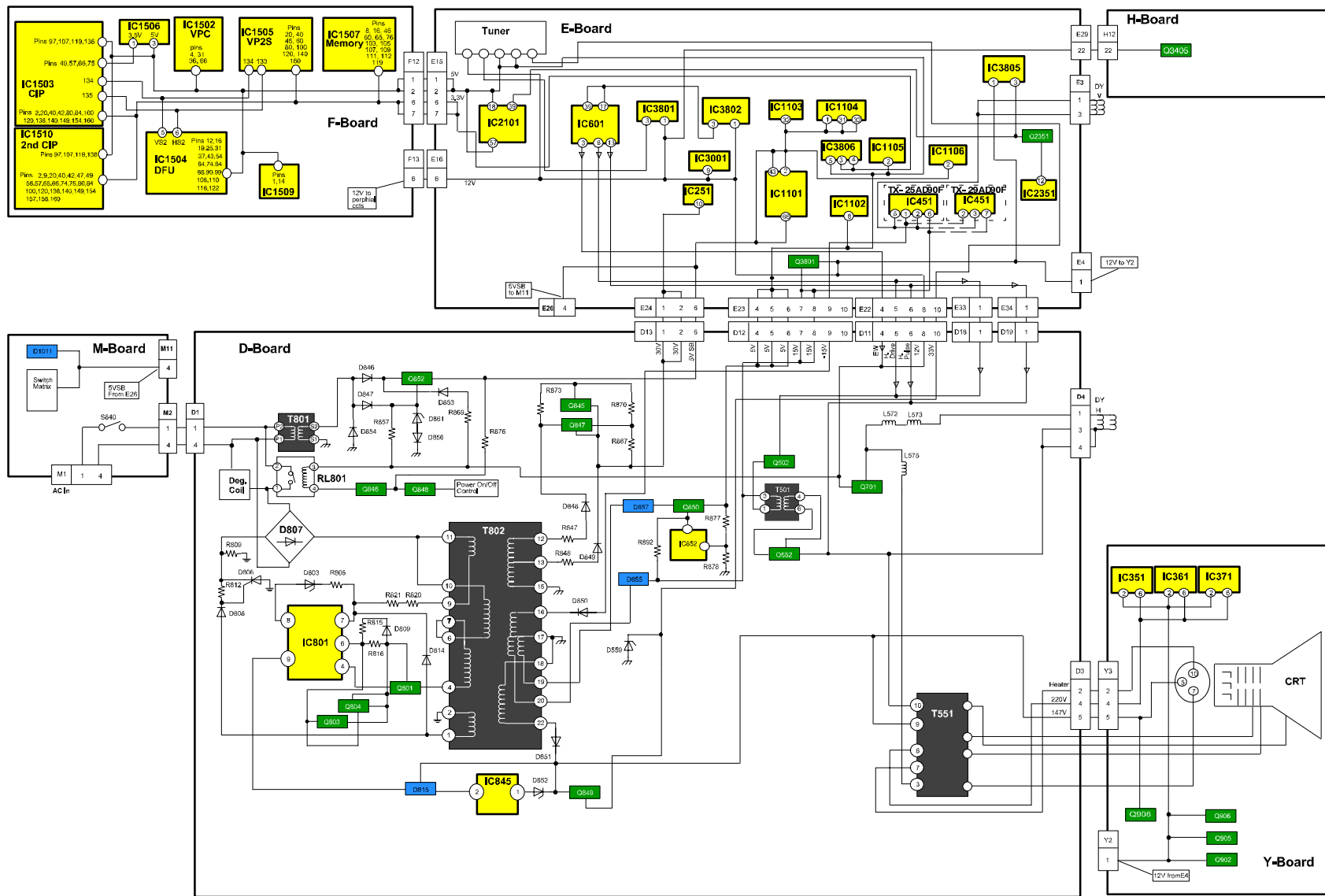

UBICAZIONE DEI COMPONENTI

NOTA:

In questa pagina numeri all' interno di un cerchio corrispondono ai numeri riportanti nell'elenco parti di ricambio.

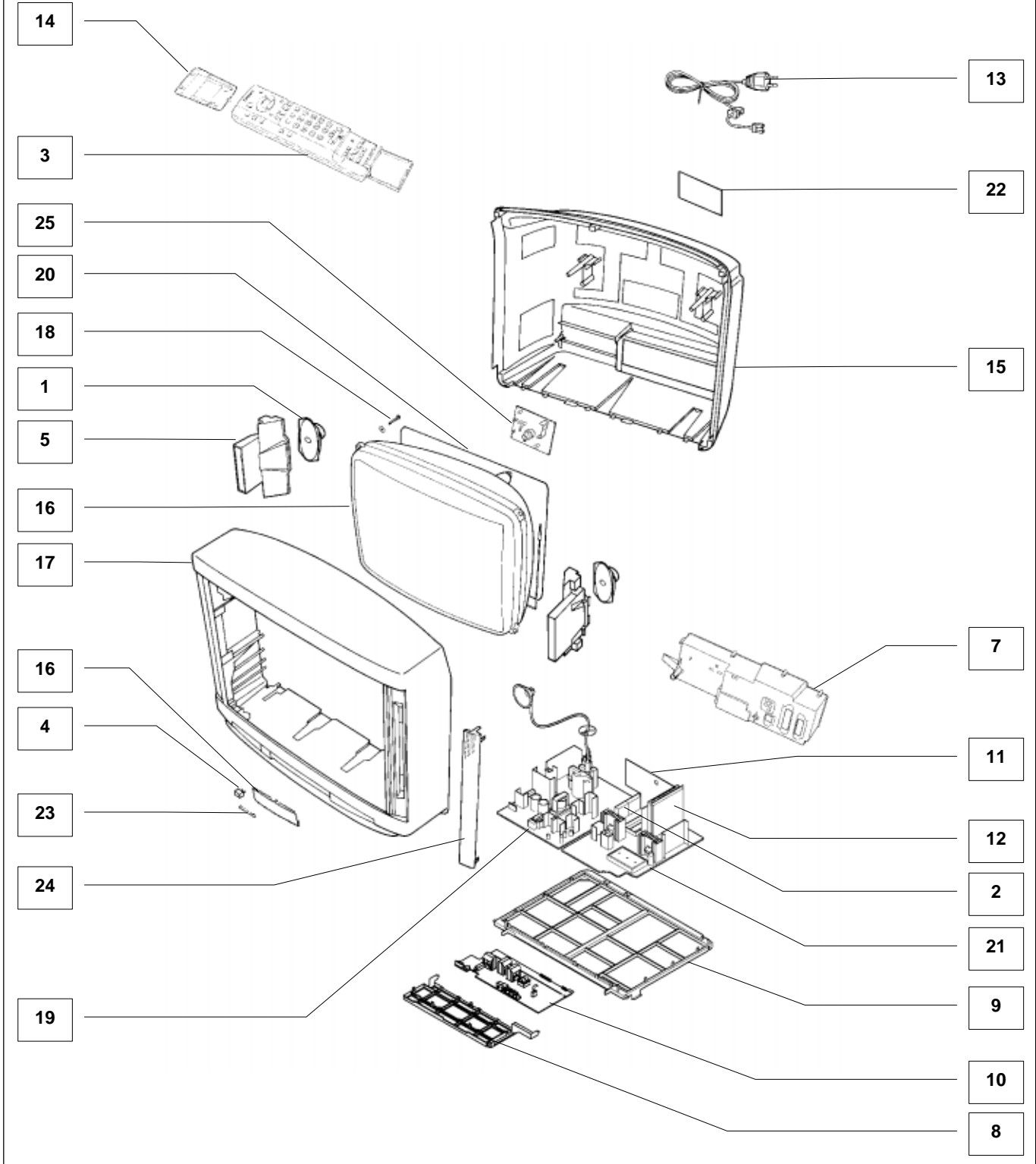

ELENCO PARTI DI RICAMBIO

Nota

Componenti contrassegnati  sono di sicurezza e devono essere sostituiti solo con quelli specificati.

* Quando ordinate questi ricambi, dovete assolutamente sempre riportare il modello esatto e completo del TV riportato nell'etichetta posteriore del televisore.

Cct Ref	Parts Number	Description
COMMON PARTS		
MECHANICAL PARTS		
1	EAGG1218H2	SPEAKER
2	ENG29505G	TUNER
3	EUR511211	REMOTE CONTROL
4	TBX8E033	POWER BUTTON
5	TKK8E026	SPEAKER REFLECTOR
6	TKP8E1149	DOOR LID
7	TKP8E1253-3	REAR AV PANEL
8	TMW8E024-5	CONTROL BRACKET
9	TMX8E028	CHASSIS FRAME
10	TNP8EM014AA	M P.C.B.
11	TNPA1047AD	H P.C.B.
12	TNPA1068AC	F P.C.B.
13	TSX8E0033	POWER CORD
14	UR51EC904A	BATTERY COVER (REMOTE)
MISCELLANEOUS COMPONENTS		
	832AG11D-ESL	IC SOCKET
	PLCC-84-T	84 PIN IC SOCKET
	TBM8E1532-2	PRESET PANEL
	TEK6940	LID CATCH
	TKP8E1150	LEFT PANEL
	TKP8E1161	RIGHT PANEL
	TMW8E017	LED HOLDER
	TMX8E025	P.C.B. BRACKET
	UM-3DJ-2P	BATTERY PACK
	ZTUZAE550A	ANODE LEAD
RL801	TSE1885-1	RELAY
R805	232266296706	THERMISTOR
SOD1	31221212478	FIX CLIP
SOD9	31221212478	FIX CLIP
INSTRUCTION BOOKS		
	TQB8E2680A-2	GERMAN
	TQB8E2680BD1	DUTCH/FRENCH
	TQB8E2680CE1	ITALIAN/SPANISH
	TQB8E2680FG1	SWEDISH/NORG.
	TQB8E2680HK1	SUOMI/DANISH
I.C.s		
IC251	LA4282	AUDIO OUTPUT
IC351	TDA6111Q-N4	RGB OUTPUT
IC361	TDA6111Q-N4	RGB OUTPUT
IC371	TDA6111Q-N4	RGB OUTPUT
IC381	TL431ACLPM	REGULATOR
IC601	TDA9330HN1G	VIDEO PROCESSOR
IC801	AN8029	POWER SUPPLY
IC845	SE140N	ERROR AMPLIFER

Cct Ref	Parts Number	Description
IC852	TL431ACLPM	REGULATOR
IC1011	RPM-637CBRS1	LED RECEIVER
IC1101	SDA5450C48-1	MICRO PROCESSOR
IC1104	27C2001-H08	EPROM *
IC1105	MN1381-T(TA)	RESET
IC1106	MN1381-R(TA)	RESET
IC1502	VPC3215CB4TP	VPC
IC1503	MB87F1720	CIP
IC1504	FJB007S	DFU
IC1505	MB87F2131	VP2S
IC1506	AN77L035M-E1	3.5V REGULATOR
IC1507	MB87H2010	MEMORY
IC1509	TLC2932IPWL	CLOCK CONVERTOR
IC1510	MB87F1720	CIP
IC2101	MSP3410DPPB4	AUDIO PROCESSOR
IC2351	AN7108	H.P. AMPLIFIER
IC3001	TEA6415C	VIDEO SWITCH
IC3801	AN7809FLB	9V REGULATOR
IC3802	AN7708FLB	8V REGULATOR
IC3805	AN7808LB	8V REGULATOR
IC3806	SI-3033C	3.5V REGULATOR
FUSES		
F840	XBA2C50TH15	FUSE
F845	TR5-T3150	FUSE
F846	TR5-T1250	FUSE
F8401	EYF52BC	FUSE HOLDER
F8402	EYF52BC	FUSE HOLDER
DIODES		
D001	MA4020	DIODE
D002	MA4020	DIODE
D252	MA165TA5	DIODE
D253	MA700TA5	DIODE
D254	MA700TA5	DIODE
D255	MA165TA5	DIODE
D351	ERA15-04V3	DIODE
D352	ERA15-04V3	DIODE
D361	ERA15-04V3	DIODE
D362	ERA15-04V3	DIODE
D371	ERA15-04V3	DIODE
D372	ERA15-04V3	DIODE
D387	MA2160LFS	DIODE
D400	MA4104	DIODE
D401	MA165TA5	DIODE
D402	MA165TA5	DIODE
D404	EU02AV1	DIODE
D405	MA165TA5	DIODE
D408	MA165TA5	DIODE
D502	1SS254T-77	DIODE
D503	EU02	DIODE
D504	EU02	DIODE
D505	ERA81004V3	DIODE
D551	EU02	DIODE

Cct Ref	Parts Number	Description
D556	AU02V0	DIODE
D559	MTZJT-7736A	DIODE
D560	1SS252T-77	DIODE
D561	1SS254T-77	DIODE
D563	RH3GLF102	DIODE
D565	MTZJT-7736A	DIODE
D566	MA165TA5	DIODE
D571	FMV-3GULF730	DIODE
D575	1SS252T-77	DIODE
D601	MA29TA5	DIODE
D603	MA4075	DIODE
D605	MA4062	DIODE
D607	MA165TA5	DIODE
D610	MA4043	DIODE
D611	MA165TA5	DIODE
D612	MA165TA5	DIODE
D615	MA165TA5	DIODE
D616	MA178TA5	DIODE
D617	MTZJT-779.1C	DIODE
D618	MTZJT-779.1C	DIODE
D621	MTZJT-778.2A	DIODE
D651	MA165TA5	DIODE
D701	AU02V0	DIODE
D803	MTZJT-7712C	DIODE
D806	TF361MALF3	DIODE
D807	RBV-608LF-B	DIODE
D808	MA165TA5	DIODE
D809	ERA22-02V3	DIODE
D810	MA2180BLFS	DIODE
D812	MTZJT-775.6B	DIODE
D813	MA700TA5	DIODE
D814	AU01ZV0	DIODE
D815	PC123FY2	DIODE
D817	D5L60F4015	DIODE
D818	TMPG10G3	DIODE
D819	ERA81004V3	DIODE
D820	MA4100	DIODE
D821	EU02AV0	DIODE
D845	MA165TA5	DIODE
D846	EK04V0	DIODE
D847	ERA15-01V3	DIODE
D848	EU02	DIODE
D849	FMGG26S	DIODE
D850	ERB32-02E	DIODE
D851	FMGG2CSLF116	DIODE
D852	MA4062	DIODE
D853	1N4150T-77	DIODE
D854	ERA15-01V3	DIODE
D855	D10SC6MRL	DIODE
D856	MA165TA5	DIODE
D857	FML22SLF610	DIODE
D860	1SS254T-77	DIODE
D861	MTZJT-775.1C	DIODE
D901	1SS254T-77	DIODE
D902	1SS254T-77	DIODE
D903	1SS254T-77	DIODE
D910	R2KNV	DIODE
D1011	LN81RPHL	DIODE
D1102	MA4051	DIODE
D1103	MA4051	DIODE
D1104	MA165TA5	DIODE
D1105	MA165TA5	DIODE
D1107	MA165TA5	DIODE
D1109	MA165TA5	DIODE
D1110	MA165TA5	DIODE
D1112	MA165TA5	DIODE

Cct Ref	Parts Number	Description
D1501	MA151ATX	DIODE
D2101	MTZJT-7712C	DIODE
D2102	MTZJT-7712C	DIODE
D2351	MTZJT-775.6B	DIODE
D3006	MA4100	DIODE
D3008	MA723TA5	DIODE
D3009	MA170	DIODE
D3011	MA858TA5	DIODE
D3351	1SS254T-77	DIODE
D3352	MA165TA5	DIODE
D3353	MA165TA5	DIODE
D3354	MA165TA5	DIODE
D3401	MTZJT-7712C	DIODE
D3803	MA4043	DIODE
D3804	MTZJT-778.2A	DIODE
D3805	ERA81004V3	DIODE
D3990	MTZJT-7724D	DIODE
Q846	BC547B/126	DIODE
Q847	BC557B/126	DIODE
Q848	BC547B/126	DIODE
Q1011	BC557B/126	DIODE
TRANSISTORS		
Q101	BC847B	TRANSISTOR
Q103	BC847B	TRANSISTOR
Q104	BC847B	TRANSISTOR
Q251	2SD1328STX	TRANSISTOR
Q252	2SD1328STX	TRANSISTOR
Q253	BC847B	TRANSISTOR
Q254	BC857B	TRANSISTOR
Q400	BC847B	TRANSISTOR
Q401	BC847B	TRANSISTOR
Q502	2SC2925STA	TRANSISTOR
Q552	2SC5144LB230	TRANSISTOR
Q553	2SC1473-RN	TRANSISTOR
Q554	2SC1473-RN	TRANSISTOR
Q602	BC857B	TRANSISTOR
Q603	BC857B	TRANSISTOR
Q604	BC857B	TRANSISTOR
Q607	BC857B	TRANSISTOR
Q608	BC857B	TRANSISTOR
Q701	2SK2538000LB	TRANSISTOR
Q801	2SK1365LB106	TRANSISTOR
Q803	2SD965-R	TRANSISTOR
Q804	2SA719-TA	TRANSISTOR
Q845	2SA684R	TRANSISTOR
Q849	2SA1018QTA	TRANSISTOR
Q850	2SD1474PLB	TRANSISTOR
Q852	2SC1318-S	TRANSISTOR
Q853	BC557C/126	TRANSISTOR
Q854	BC557C/126	TRANSISTOR
Q902	BC847B	TRANSISTOR
Q903	BC847B	TRANSISTOR
Q904	BC857B	TRANSISTOR
Q905	BC847B	TRANSISTOR
Q906	BC847B	TRANSISTOR
Q907	BC857B	TRANSISTOR
Q908	2SA1535ARLB	TRANSISTOR
Q909	2SC3944ARLB	TRANSISTOR
Q1103	BC847B	TRANSISTOR
Q1104	BC847B	TRANSISTOR
Q1105	BC847B	TRANSISTOR
Q1106	BC847B	TRANSISTOR
Q1107	BC847B	TRANSISTOR
Q1108	BC847B	TRANSISTOR
Q1109	BC847B	TRANSISTOR
Q1110	BC847B	TRANSISTOR

Cct Ref	Parts Number	Description
Q1111	BC847B	TRANSISTOR
Q1112	BC847B	TRANSISTOR
Q1113	BC847B	TRANSISTOR
Q1118	BC857B	TRANSISTOR
Q1501	BC857B	TRANSISTOR
Q1502	BC857B	TRANSISTOR
Q1503	BC847B	TRANSISTOR
Q1504	BC847B	TRANSISTOR
Q1505	BC847B	TRANSISTOR
Q1506	BC847B	TRANSISTOR
Q1507	BC847B	TRANSISTOR
Q1508	BC847B	TRANSISTOR
Q1509	BC847B	TRANSISTOR
Q1510	BC847B	TRANSISTOR
Q1511	BC847B	TRANSISTOR
Q1513	BC857B	TRANSISTOR
Q1660	BC847B	TRANSISTOR
Q1661	BC847B	TRANSISTOR
Q1662	BC847B	TRANSISTOR
Q1663	BC847B	TRANSISTOR
Q1664	BC847B	TRANSISTOR
Q1665	BC847B	TRANSISTOR
Q1666	BC847B	TRANSISTOR
Q1667	BC847B	TRANSISTOR
Q2101	BC860B	TRANSISTOR
Q2102	BC860B	TRANSISTOR
Q2301	BC847B	TRANSISTOR
Q2302	BC847B	TRANSISTOR
Q2305	BC857B	TRANSISTOR
Q2307	BC860B	TRANSISTOR
Q2308	BC860B	TRANSISTOR
Q2351	BC847B	TRANSISTOR
Q2352	BC847B	TRANSISTOR
Q3001	BC857B	TRANSISTOR
Q3002	BC847B	TRANSISTOR
Q3003	BC847B	TRANSISTOR
Q3005	BC847B	TRANSISTOR
Q3006	BC847B	TRANSISTOR
Q3010	BC857B	TRANSISTOR
Q3011	BC857B	TRANSISTOR
Q3012	BC847B	TRANSISTOR
Q3013	BC847B	TRANSISTOR
Q3014	BC847B	TRANSISTOR
Q3351	BC847B	TRANSISTOR
Q3352	BC857B	TRANSISTOR
Q3401	BC847B	TRANSISTOR
Q3402	BC847B	TRANSISTOR
Q3403	BC847B	TRANSISTOR
Q3404	BC847B	TRANSISTOR
Q3405	BC847B	TRANSISTOR
Q3801	2SD1474PLB	TRANSISTOR
Q3990	BC847B	TRANSISTOR
TRANSFORMERS		
T501	ETH19Y187AY	TRANSFORMER
T801	ETP35KAN619U	TRANSFORMER
T802	ETS49AH1W7AD	TRANSFORMER
COILS		
L002	EXCELD35V	COIL
L003	EXCELD35V	COIL
L004	EXCELSA35T	COIL
L005	TLT100K991R	COIL
L007	EXCELD35V	COIL
L008	ELJFC2R2KF	COIL
L009	ELJFC2R2KF	COIL
L251	EXCELSA35T	COIL
L252	EXCELSA35T	COIL

△
△
△

Cct Ref	Parts Number	Description
L253	EXCELSA35T	COIL
L254	EXCELSA35T	COIL
L351	SDL5000	DELAY LINE
L361	SDL5000	DELAY LINE
L371	SDL5000	DELAY LINE
L381	TLT220K991R	COIL
L501	ELELN101KA	COIL
L554	EXCELD35V	COIL
L556	EXCELD35C	COIL
L572	ELHKL025B	COIL
L573	ELHKL026B	COIL
L575	ELC18B271E	COIL
L601	EXCELD35V	COIL
L602	EXCELD35V	COIL
L603	TLT033K991R	COIL
L604	ELEXT2R7KA	COIL
L605	ELEXT2R7KA	COIL
L606	ELEXT2R7KA	COIL
L607	ELEXT2R7KA	COIL
L806	EXCELSA39V	COIL
L808	EXCELSA39V	COIL
L809	EXCELD35C	COIL
L810	EXCELSA39V	COIL
L811	EXCELSA39V	COIL
L812	EXCELD35V	COIL
L813	EXCELD35V	COIL
L817	EXCELD35V	COIL
L819	EXCELSA39V	COIL
L842	ELF18D486D	COIL
L843	ELF18D486D	COIL
L845	EXCELSA35T	COIL
L847	EXCELSA35B	COIL
L849	EXCELSA35T	COIL
L854	ELEIE150KA	COIL
L859	EXCELSA35T	COIL
L860	EXCELSA35T	COIL
L861	EXCELSA35T	COIL
L910	EXCELSA35T	COIL
L911	EXCELSA35T	COIL
L912	EXCELSA35T	COIL
L1101	EXCELD35V	COIL
L1103	TLT047K991R	COIL
L1104	EXCELD35V	COIL
L1105	EXCELD35V	COIL
L1106	TLT047K991R	COIL
L1507	TLT018K991R	COIL
L1508	TLT033K991R	COIL
L1509	EXCELD35V	COIL
L1510	EXCELD35V	COIL
L1511	TLT018K991R	COIL
L1516	EXCELD35V	COIL
L1519	EXCEMT103DTM	COIL
L1523	EXCEMT103DTM	COIL
L1525	EXCEMT103DTM	COIL
L1527	EXCEMT103DTM	COIL
L1528	EXCELD35V	COIL
L1529	EXCELD35V	COIL
L1532	EXCELD35V	COIL
L1533	EXCELD35V	COIL
L1534	EXCELD35V	COIL
L1535	EXCELD35V	COIL
L1536	EXCELD35V	COIL
L1537	TLT100K991R	COIL
L1538	TLT018K991R	COIL
L1539	TLT033K991R	COIL
L1540	TLT018K991R	COIL

Cct Ref	Parts Number	Description
L1541	TLT033K991R	COIL
L1542	TLT018K991R	COIL
L1543	TLT033K991R	COIL
L2101	TLT100K991R	COIL
L2102	TLT039K991R	COIL
L2103	TLT100K991R	COIL
L2104	EXCELD35V	COIL
L2106	TLT068K991R	COIL
L2381	EXCELSA35T	COIL
L2382	EXCELSA35T	COIL
L2412	EXCELSA35T	COIL
L2413	EXCELSA35T	COIL
L3001	TLT100K991R	COIL
L3205	EXCELD35V	COIL
L3281	EXCELSA35T	COIL
L3282	EXCELSA35T	COIL
L3401	TLT015K991R	COIL
L3402	TLT015K991R	COIL
L3403	TLT015K991R	COIL
L3404	TLT015K991R	COIL
L3405	TLT015K991R	COIL
L3406	TLT015K991R	COIL
L3407	TLT015K991R	COIL
L3408	TLT015K991R	COIL
L3409	TLT100K991R	COIL
L3801	EXCELD35V	COIL
FILTERS		
L807	ELF18D850C	LINE FILTER
T803	ETQ24K37AY	LINE FILTER
X101	EFCT6504BF	FILTER
X102	EFCT7004BF	CERAMIC FILTER
CRYSTALS		
X601	TSSA010	CRYSTAL
X1101	TSSA121	CRYSTAL
X1501	TSS2169-B	CRYSTAL
X2101	4730007158	CRYSTAL
RESISTORS		
	ERC12GK825	SOLID 0.5W 10% 8M2 Ω
	ERD25TC0T	CARBON 0.25W 5% 0 Ω
C3827	ERJ6GEY0R00	S.M.CARB 0.1W 5% 0 Ω
JA1	ERJ6GEY0R00	S.M.CARB 0.1W 5% 0 Ω
JA1	ERJ8GEY0R00	S.M.CARB .125W 5% 0 Ω
JA2	ERJ6GEY0R00	S.M.CARB 0.1W 5% 0 Ω
JA2	ERJ8GEY0R00	S.M.CARB .125W 5% 0 Ω
JA3	ERJ6GEY0R00	S.M.CARB 0.1W 5% 0 Ω
JA3	ERJ8GEY0R00	S.M.CARB .125W 5% 0 Ω
JA4	ERJ6GEY0R00	S.M.CARB 0.1W 5% 0 Ω
JA4	ERJ8GEY0R00	S.M.CARB .125W 5% 0 Ω
JA5	ERJ8GEY0R00	S.M.CARB .125W 5% 0 Ω
JA6	ERJ8GEY0R00	S.M.CARB .125W 5% 0 Ω
JA7	ERJ8GEY0R00	S.M.CARB .125W 5% 0 Ω
JA8	ERJ8GEY0R00	S.M.CARB .125W 5% 0 Ω
JA9	ERJ6GEY0R00	S.M.CARB 0.1W 5% 0 Ω
JA11	ERJ6GEY0R00	S.M.CARB 0.1W 5% 0 Ω
JA12	ERJ6GEY0R00	S.M.CARB 0.1W 5% 0 Ω
JA13	ERJ8GEY0R00	S.M.CARB .125W 5% 0 Ω
JA14	ERJ8GEY0R00	S.M.CARB .125W 5% 0 Ω
JA15	ERJ8GEY0R00	S.M.CARB .125W 5% 0 Ω
JA16	ERJ8GEY0R00	S.M.CARB .125W 5% 0 Ω
JA18	ERJ6GEY0R00	S.M.CARB 0.1W 5% 0 Ω
JA19	ERJ6GEY0R00	S.M.CARB 0.1W 5% 0 Ω
JA20	ERJ8GEY0R00	S.M.CARB .125W 5% 0 Ω
JA21	ERJ6GEY0R00	S.M.CARB 0.1W 5% 0 Ω
JA23	ERJ6GEY0R00	S.M.CARB 0.1W 5% 0 Ω
JA24	ERJ6GEY0R00	S.M.CARB 0.1W 5% 0 Ω

Cct Ref	Parts Number	Description
JA26	ERJ6GEY0R00	S.M.CARB 0.1W 5% 0 Ω
JA27	ERJ6GEY0R00	S.M.CARB 0.1W 5% 0 Ω
JA29	ERJ6GEY0R00	S.M.CARB 0.1W 5% 0 Ω
JA30	ERJ6GEY0R00	S.M.CARB 0.1W 5% 0 Ω
JA31	ERJ6GEY0R00	S.M.CARB 0.1W 5% 0 Ω
JA33	ERJ6GEY0R00	S.M.CARB 0.1W 5% 0 Ω
JA35	ERJ8GEY0R00	S.M.CARB .125W 5% 0 Ω
JA36	ERJ6GEY0R00	S.M.CARB 0.1W 5% 0 Ω
JA37	ERJ6GEY0R00	S.M.CARB 0.1W 5% 0 Ω
JSE045	ERD25TJ2R2	CARBON 0.25W 5% 2R2 Ω
JSF015	ERJ6GEY0R00	S.M.CARB 0.1W 5% 0 Ω
JSE009	ERJ6GEY0R00	S.M.CARB 0.1W 5% 0 Ω
JSE025	ERJ6GEY0R00	S.M.CARB 0.1W 5% 0 Ω
JSE028	ERJ6GEY0R00	S.M.CARB 0.1W 5% 0 Ω
JSE044	ERJ6GEY0R00	S.M.CARB 0.1W 5% 0 Ω
JSF001	ERJ6GEY0R00	S.M.CARB 0.1W 5% 0 Ω
JSF005	ERJ6GEY0R00	S.M.CARB 0.1W 5% 0 Ω
JSF006	ERJ6GEY0R00	S.M.CARB 0.1W 5% 0 Ω
JSF007	ERJ6GEY0R00	S.M.CARB 0.1W 5% 0 Ω
JSF009	ERJ6GEY0R00	S.M.CARB 0.1W 5% 0 Ω
JSE004	ERJ6GEY0R00	S.M.CARB 0.1W 5% 0 Ω
JSF027	ERJ6GEY0R00	S.M.CARB 0.1W 5% 0 Ω
JSY04	ERJ6GEY0R00	S.M.CARB 0.1W 5% 0 Ω
JSY03	ERJ6GEY0R00	S.M.CARB 0.1W 5% 0 Ω
JSH010	ERJ6GEY0R00	S.M.CARB 0.1W 5% 0 Ω
JSH002	ERJ6GEY0R00	S.M.CARB 0.1W 5% 0 Ω
JSF043	ERJ6GEY0R00	S.M.CARB 0.1W 5% 0 Ω
JSF042	ERJ6GEY0R00	S.M.CARB 0.1W 5% 0 Ω
JSF041	ERJ6GEY0R00	S.M.CARB 0.1W 5% 0 Ω
JSF039	ERJ6GEY0R00	S.M.CARB 0.1W 5% 0 Ω
JSF037	ERJ6GEY0R00	S.M.CARB 0.1W 5% 0 Ω
JSF034	ERJ6GEY0R00	S.M.CARB 0.1W 5% 0 Ω
JSF032	ERJ6GEY0R00	S.M.CARB 0.1W 5% 0 Ω
JSF010	ERJ6GEY0R00	S.M.CARB 0.1W 5% 0 Ω
JSF028	ERJ6GEY0R00	S.M.CARB 0.1W 5% 0 Ω
JSF013	ERJ6GEY0R00	S.M.CARB 0.1W 5% 0 Ω
JSF026	ERJ6GEY0R00	S.M.CARB 0.1W 5% 0 Ω
JSF025	ERJ6GEY0R00	S.M.CARB 0.1W 5% 0 Ω
JSF024	ERJ6GEY0R00	S.M.CARB 0.1W 5% 0 Ω
JSF023	ERJ6GEY0R00	S.M.CARB 0.1W 5% 0 Ω
JSF022	ERJ6GEY0R00	S.M.CARB 0.1W 5% 0 Ω
JSF021	ERJ6GEY0R00	S.M.CARB 0.1W 5% 0 Ω
JSF020	ERJ6GEY0R00	S.M.CARB 0.1W 5% 0 Ω
JSF019	ERJ6GEY0R00	S.M.CARB 0.1W 5% 0 Ω
JSF018	ERJ6GEY0R00	S.M.CARB 0.1W 5% 0 Ω
JSF017	ERJ6GEY0R00	S.M.CARB 0.1W 5% 0 Ω
JSE011	ERJ6GEY0R00	S.M.CARB 0.1W 5% 0 Ω
JSF029	ERJ6GEY0R00	S.M.CARB 0.1W 5% 0 Ω
JSE026	ERJ6GEY0R00	S.M.CARB 0.1W 5% 0 Ω
R001	ERJ6GEYJ223	S.M.CARB 0.1W 5% 22K Ω
R002	ERJ6GEYJ101	S.M.CARB 0.1W 5% 100 Ω
R003	ERJ6GEYJ393	S.M.CARB 0.1W 5% 39K Ω
R101	ERJ6GEYJ561	S.M.CARB 0.1W 5% 560 Ω
R102	ERJ6GEYJ101	S.M.CARB 0.1W 5% 100 Ω
R103	ERJ6GEYJ563	S.M.CARB 0.1W 5% 56K Ω
R104	ERJ6GEYJ471	S.M.CARB 0.1W 5% 470 Ω
R105	ERJ6GEYJ332	S.M.CARB 0.1W 5% 3K3 Ω
R106	ERJ6GEYJ821	S.M.CARB 0.1W 5% 820 Ω
R107	ERJ6GEYJ102	S.M.CARB 0.1W 5% 1K Ω
R109	ERJ6GEYJ103	S.M.CARB 0.1W 5% 10K Ω
R110	ERJ6GEYJ222	S.M.CARB 0.1W 5% 2K2 Ω
R111	ERJ6GEYJ331	S.M.CARB 0.1W 5% 330 Ω
R251	ERJ6GEYJ271	S.M.CARB 0.1W 5% 270 Ω
R252	ERJ6GEYJ223	S.M.CARB 0.1W 5% 22K Ω
R253	ERJ6GEYJ103	S.M.CARB 0.1W 5% 10K Ω
R254	ERJ6GEYJ271	S.M.CARB 0.1W 5% 270 Ω

Cct Ref	Parts Number	Description			
R255	ERJ6GEYJ103	S.M.CARB	0.1W	5%	10K Ω
R256	ERJ6GEYJ681	S.M.CARB	0.1W	5%	680 Ω
R257	ERJ6GEY0R00	S.M.CARB	0.1W	5%	0 Ω
R258	ERJ6GEYJ223	S.M.CARB	0.1W	5%	22K Ω
R259	ERJ6GEY0R00	S.M.CARB	0.1W	5%	0 Ω
R260	ERJ6GEYJ103	S.M.CARB	0.1W	5%	10K Ω
R261	ERJ6GEYJ681	S.M.CARB	0.1W	5%	680 Ω
R262	ERJ6GEYJ103	S.M.CARB	0.1W	5%	10K Ω
R263	ERJ6GEYJ104	S.M.CARB	0.1W	5%	100K Ω
R264	ERJ6GEYJ473	S.M.CARB	0.1W	5%	47K Ω
R265	ERDS1TJ2R2	CARBON	0.5W	5%	2R2 Ω
R266	ERDS1TJ2R2	CARBON	0.5W	5%	2R2 Ω
R269	ERJ6GEYJ273	S.M.CARB	0.1W	5%	27K Ω
R270	ERJ6GEYJ273	S.M.CARB	0.1W	5%	27K Ω
R271	ERJ6GEYJ272	S.M.CARB	0.1W	5%	2K7 Ω
R272	ERJ6GEYJ103	S.M.CARB	0.1W	5%	10K Ω
R273	ERJ6GEYJ331	S.M.CARB	0.1W	5%	330 Ω
R350	ERQ12AJ151P	FUSIBLE	0.5W	5%	150 Ω ^Δ
R351	ERJ6GEYJ102	S.M.CARB	0.1W	5%	1K Ω
R352	ERJ6GEYJ102	S.M.CARB	0.1W	5%	1K Ω
R354	ERO25CKF4122	METAL	0.25W	5%	1K2 Ω ^Δ
R355	ERG2FG823H	METAL	2W	5%	82K Ω ^Δ
R356	ERJ6GEYJ181	S.M.CARB	0.1W	5%	180 Ω
R357	ERJ6GEYJ822	S.M.CARB	0.1W	5%	8K2 Ω
R358	ERDS1TJ821	CARBON	0.5W	5%	820 Ω
R360	ERO50PKF8251	METAL	0.5W	5%	8M2 Ω ^Δ
R361	ERJ6GEYJ102	S.M.CARB	0.1W	5%	1K Ω
R362	ERJ6GEYJ102	S.M.CARB	0.1W	5%	1K Ω
R364	ERO25CKF4122	METAL	0.25W	5%	1K2 Ω ^Δ
R365	ERG2FG823H	METAL	2W	5%	82K Ω ^Δ
R366	ERJ6GEYJ181	S.M.CARB	0.1W	5%	180 Ω
R367	ERJ6GEYJ822	S.M.CARB	0.1W	5%	8K2 Ω
R368	ERDS1TJ821	CARBON	0.5W	5%	820 Ω
R369	ERJ6GEY0R00	S.M.CARB	0.1W	5%	0 Ω
R370	ERQ1CKPR68	FUSIBLE	1W	10%	R68 Ω ^Δ
R371	ERJ6GEYJ102	S.M.CARB	0.1W	5%	1K Ω
R372	ERJ6GEYJ102	S.M.CARB	0.1W	5%	1K Ω
R374	ERO25CKF4122	METAL	0.25W	5%	1K2 Ω ^Δ
R375	ERG2FG823H	METAL	2W	5%	82K Ω ^Δ
R376	ERJ6GEYJ181	S.M.CARB	0.1W	5%	180 Ω
R377	ERJ6GEYJ822	S.M.CARB	0.1W	5%	8K2 Ω
R378	ERDS1TJ821	CARBON	0.5W	5%	820 Ω
R379	ERJ6GEY0R00	S.M.CARB	0.1W	5%	0 Ω
R383	ERJ6GEY0R00	S.M.CARB	0.1W	5%	0 Ω
R394	ERJ6ENF7500	S.M.CARB	0.1W	5%	75 Ω
R395	ERJ6ENF5900	S.M.CARB	0.1W	5%	90 Ω
R396	ERJ6ENF7500	S.M.CARB	0.1W	5%	75 Ω
R397	ERJ6ENF5900	S.M.CARB	0.1W	5%	90 Ω
R398	ERJ6ENF7500	S.M.CARB	0.1W	5%	75 Ω
R399	ERJ6ENF5900	S.M.CARB	0.1W	5%	90 Ω
R401	ERJ6GEYJ272	S.M.CARB	0.1W	5%	2K7 Ω
R402	ERJ6GEYJ682	S.M.CARB	0.1W	5%	6K8 Ω
R403	ERJ6GEYJ102	S.M.CARB	0.1W	5%	1K Ω
R404	ERJ6GEYJ103	S.M.CARB	0.1W	5%	10K Ω
R416	ERJ6GEYJ682	S.M.CARB	0.1W	5%	6K8 Ω
R418	ERJ6GEYJ682	S.M.CARB	0.1W	5%	6K8 Ω
R419	ERG3FJ471	METAL	3W	5%	470 Ω ^Δ
R420	ERJ6GEYJ563	S.M.CARB	0.1W	5%	56K Ω
R421	ERJ6GEYJ224	S.M.CARB	0.1W	5%	220K Ω
R441	ERJ6GEYJ393	S.M.CARB	0.1W	5%	39K Ω
R442	ERJ6GEYJ123	S.M.CARB	0.1W	5%	12K Ω
R452	ERDS1TJ2R7	CARBON	0.5W	5%	2R7 Ω
R453	ERJ6GEYJ393	S.M.CARB	0.1W	5%	39K Ω
R454	ERJ6GEYJ123	S.M.CARB	0.1W	5%	12K Ω
R457	ERJ6GEYJ682	S.M.CARB	0.1W	5%	6K8 Ω
R458	ERJ6GEYJ302	S.M.CARB	0.1W	5%	3K Ω

Cct Ref	Parts Number	Description			
R471	ERDS1FJ1R0	CARBON	0.5W	5%	1 Ω ^Δ
R504	ERD25TJ271	CARBON	0.25W	5%	270 Ω
R506	ERDS1TJ681	CARBON	0.5W	5%	680 Ω
R507	ERDS1TJ681	CARBON	0.5W	5%	680 Ω
R554	ERX3SJSR27H	METAL	3W	5%	R27 Ω
R556	ERDS1TJ333	CARBON	0.5W	5%	33K Ω
R557	ERDS1TJ683	CARBON	0.5W	5%	68K Ω
R558	ERDS1TJ393	CARBON	0.5W	5%	39K Ω
R560	ERD25TJ222	CARBON	0.25W	5%	2K2 Ω
R561	ERD25TJ333	CARBON	0.25W	5%	33K Ω
R562	ERD25TJ333	CARBON	0.25W	5%	33K Ω
R563	ERD25TJ223	CARBON	0.25W	5%	22K Ω
R564	ERDS1TJ394	CARBON	0.5W	5%	390K Ω
R567	ERG3FJ223	METAL	3W	5%	22K Ω ^Δ
R569	ERDS1TJ120	CARBON	0.5W	5%	12 Ω
R570	ERD25TJ103	CARBON	0.25W	5%	10K Ω
R572	ERG3FJ821	METAL	3W	5%	820 Ω ^Δ
R574	ERG3FJ151	METAL	3W	5%	150 Ω ^Δ
R579	ERD25TJ274	CARBON	0.25W	5%	270K Ω
R580	ERD25TJ563	CARBON	0.25W	5%	56K Ω
R581	ERD25TJ104	CARBON	0.25W	5%	100K Ω
R582	ERD25TJ225	CARBON	0.25W	5%	2M2 Ω
R583	ERD25TJ225	CARBON	0.25W	5%	2M2 Ω
R588	ERD25TJ332	CARBON	0.25W	5%	3K3 Ω
R601	ERJ6GEYJ153	S.M.CARB	0.1W	5%	15K Ω
R613	ERJ6GEYJ101	S.M.CARB	0.1W	5%	100 Ω
R614	ERJ6GEYJ101	S.M.CARB	0.1W	5%	100 Ω
R615	ERJ6GEYJ101	S.M.CARB	0.1W	5%	100 Ω
R616	ERJ6GEYJ100	S.M.CARB	0.1W	5%	10 Ω
R617	ERJ6GEYJ102	S.M.CARB	0.1W	5%	1K Ω
R619	ERJ6GEYJ101	S.M.CARB	0.1W	5%	100 Ω
R620	ERJ6GEYJ101	S.M.CARB	0.1W	5%	100 Ω
R622	ERJ6GEYJ393	S.M.CARB	0.1W	5%	39K Ω
R623	ERJ6GEYJ153	S.M.CARB	0.1W	5%	15K Ω
R626	ERJ6GEYJ331	S.M.CARB	0.1W	5%	330 Ω
R627	ERJ6GEYJ102	S.M.CARB	0.1W	5%	1K Ω
R628	ERJ6GEYJ472	S.M.CARB	0.1W	5%	4K7 Ω
R630	ERJ6GEYJ103	S.M.CARB	0.1W	5%	10K Ω
R631	ERJ6GEYJ105	S.M.CARB	0.1W	5%	1M Ω
R632	ERJ6GEYJ223	S.M.CARB	0.1W	5%	22K Ω
R634	ERJ6GEYJ103	S.M.CARB	0.1W	5%	10K Ω
R635	ERJ6GEYJ101	S.M.CARB	0.1W	5%	100 Ω
R636	ERJ6GEYJ101	S.M.CARB	0.1W	5%	100 Ω
R637	ERJ6GEYJ101	S.M.CARB	0.1W	5%	100 Ω
R646	ERJ6GEYJ821	S.M.CARB	0.1W	5%	820 Ω
R647	ERJ6GEYJ101	S.M.CARB	0.1W	5%	100 Ω
R648	ERJ6GEYJ101	S.M.CARB	0.1W	5%	100 Ω
R649	ERJ6GEYJ101	S.M.CARB	0.1W	5%	100 Ω
R650	ERJ6GEYJ101	S.M.CARB	0.1W	5%	100 Ω
R651	ERJ6GEYJ101	S.M.CARB	0.1W	5%	100 Ω
R652	ERJ6GEYJ101	S.M.CARB	0.1W	5%	100 Ω
R653	ERJ6GEYJ101	S.M.CARB	0.1W	5%	100 Ω
R658	ERJ6ENF2212	S.M. CAR	0.1W	5%	220 Ω
R663	ERJ6GEYJ434	S.M.CARB	0.1W	5%	43K Ω
R664	ERJ6GEYJ682	S.M.CARB	0.1W	5%	6K8 Ω
R665	ERJ6GEYJ332	S.M.CARB	0.1W	5%	3K3 Ω
R666	ERJ6GEYJ222	S.M.CARB	0.1W	5%	2K2 Ω
R667	ERJ6GEYJ433	S.M.CARB	0.1W	5%	43K Ω
R674	ERJ6GEYJ273	S.M.CARB	0.1W	5%	27K Ω
R675	ERJ6GEYJ562	S.M.CARB	0.1W	5%	5K6 Ω
R676	ERJ6GEYJ103	S.M.CARB	0.1W	5%	10K Ω
R677	ERJ6GEYJ273	S.M.CARB	0.1W	5%	27K Ω
R678	ERJ6GEYJ562	S.M.CARB	0.1W	5%	5K6 Ω
R679	ERJ6GEYJ103	S.M.CARB	0.1W	5%	10K Ω
R680	ERJ6GEYJ823	S.M.CARB	0.1W	5%	82K Ω
R681	ERJ6GEYJ103	S.M.CARB	0.1W	5%	10K Ω

Cct Ref	Parts Number	Description				
R682	ERJ6GEYJ103	S.M.CARB	0.1W	5%	10K Ω	
R683	ERJ6GEYJ103	S.M.CARB	0.1W	5%	10K Ω	
R684	ERJ6GEYJ101	S.M.CARB	0.1W	5%	100 Ω	
R685	ERJ6GEYJ103	S.M.CARB	0.1W	5%	10K Ω	
R686	ERJ6GEYJ102	S.M.CARB	0.1W	5%	1K Ω	
R688	ERJ6ENF3162	S.M. CAR	0.1W	5%	1K6 Ω	
R701	ERX3FJ2R7H	METAL	3W	5%	2R7 Ω	
R703	ERD25TJ393	CARBON	0.25W	5%	39K Ω	
R704	ERDS1TJ330	CARBON	0.5W	5%	33 Ω	
R806	ERD25TJ101	CARBON	0.25W	5%	100 Ω	
R807	ERD25TJ104	CARBON	0.25W	5%	100K Ω	
R809	ERF10ZK4R7	WOUND	10W	5%	4R7 Ω	△
R810	ERD25TJ223	CARBON	0.25W	5%	22K Ω	
R811	ERD25TJ391	CARBON	0.25W	5%	390 Ω	
R812	ERD25TJ681	CARBON	0.25W	5%	680 Ω	
R814	ERD25TJ392	CARBON	0.25W	5%	3K9 Ω	
R815	ERD25TJ100	CARBON	0.25W	5%	10 Ω	
R816	ERDS1TJ330	CARBON	0.5W	5%	33 Ω	
R818	ERD25TJ511	CARBON	0.25W	5%	510 Ω	
R820	ERG3FJ223	METAL	3W	5%	22K Ω	△
R821	ERG3FJ223	METAL	3W	5%	22K Ω	△
R822	ERD25TJ391	CARBON	0.25W	5%	390 Ω	
R823	ERX12SJR22	METAL	0.5W	5%	R22 Ω	
R824	ERX12SJR22	METAL	0.5W	5%	R22 Ω	
R825	ERX12SJR22	METAL	0.5W	5%	R22 Ω	
R827	ERDS1FJ121	CARBON	0.5W	5%	120 Ω	△
R828	ERD25TJ103	CARBON	0.25W	5%	10K Ω	
R829	ERD25TJ221	CARBON	0.25W	5%	220 Ω	
R830	ERX12SJR22	METAL	0.5W	5%	R22 Ω	
R831	ERD75TAJ825	CARBON	0.75W	5%	8M2 Ω	△
R832	ERG3FJ331	METAL	3W	5%	330 Ω	△
R835	ERD25TJ220	CARBON	0.25W	5%	22 Ω	
R836	ERD25TJ100	CARBON	0.25W	5%	10 Ω	
R837	ERD25TJ183	CARBON	0.25W	5%	18K Ω	
R838	ERD25TJ821	CARBON	0.25W	5%	820 Ω	
R841	ERC12ZGK105D	SOLID	0.5W	10%	1M Ω	
R857	ERD25TJ221	CARBON	0.25W	5%	220 Ω	
R862	ERD25TJ272	CARBON	0.25W	5%	2K7 Ω	
R863	ERG3FJ680H	METAL	3W	5%	68 Ω	△
R864	ERDS1TJ682	CARBON	0.5W	5%	6K8 Ω	
R867	ERD25TJ102	CARBON	0.25W	5%	1K Ω	
R868	ERD25TJ151	CARBON	0.25W	5%	150 Ω	
R869	ERD25TJ560	CARBON	0.25W	5%	56 Ω	
R870	ERD25TJ101	CARBON	0.25W	5%	100 Ω	
R873	ERQ2CJP2R4	METAL	2W	5%	2R4 Ω	△
R876	ERD25TJ562	CARBON	0.25W	5%	5K6 Ω	
R877	ERO25CKF1022	METAL	0.25W	1%	10K2 Ω	△
R878	ERO25CKF1002	METAL	0.25W	1%	10K Ω	△
R883	ERD25TJ103	CARBON	0.25W	5%	10K Ω	
R885	ERD25TJ103	CARBON	0.25W	5%	10K Ω	
R886	ERX3SJR56	METAL	3W	5%	R56 Ω	
R888	ERDS1TJ393	CARBON	0.5W	5%	39K Ω	
R889	ERD25TJ392	CARBON	0.25W	5%	3K9 Ω	
R891	ERD25TJ103	CARBON	0.25W	5%	10K Ω	
R892	ERD25TJ222	CARBON	0.25W	5%	2K2 Ω	
R897	ERD25TJ183	CARBON	0.25W	5%	18K Ω	
R901	ERJ6GEYJ562	S.M.CARB	0.1W	5%	5K6 Ω	
R902	ERJ6GEYJ562	S.M.CARB	0.1W	5%	5K6 Ω	
R903	ERJ6GEYJ562	S.M.CARB	0.1W	5%	5K6 Ω	
R904	ERJ6GEYJ102	S.M.CARB	0.1W	5%	1K Ω	
R906	ERJ6GEYJ563	S.M.CARB	0.1W	5%	56K Ω	
R907	ERJ6GEYJ822	S.M.CARB	0.1W	5%	8K2 Ω	
R908	ERJ6GEYJ471	S.M.CARB	0.1W	5%	470 Ω	
R909	ERJ6GEYJ102	S.M.CARB	0.1W	5%	1K Ω	
R910	ERJ6GEYJ221	S.M.CARB	0.1W	5%	220 Ω	
R911	ERD25TJ561	CARBON	0.25W	5%	560 Ω	

Cct Ref	Parts Number	Description				
R913	ERJ6GEYJ183	S.M.CARB	0.1W	5%	18K Ω	
R914	ERJ6GEYJ222	S.M.CARB	0.1W	5%	2K2 Ω	
R915	ERJ6GEYJ182	S.M.CARB	0.1W	5%	1K8 Ω	
R916	ERJ6GEYJ221	S.M.CARB	0.1W	5%	220 Ω	
R917	ERJ6GEYJ121	S.M.CARB	0.1W	5%	120 Ω	
R919	ERQ14AJW390	FUSIBLE	0.25W	5%	39 Ω	△
R920	ERQ14AJW390	FUSIBLE	0.25W	5%	39 Ω	△
R922	ERD25TJ683	CARBON	0.25W	5%	68K Ω	
R923	ERD25TJ683	CARBON	0.25W	5%	68K Ω	
R924	ERDS1FYJ390	CARBON	0.5W	5%	39 Ω	△
R925	ERJ6GEY0R00	S.M.CARB	0.1W	5%	0 Ω	
R926	ERJ6GEY0R00	S.M.CARB	0.1W	5%	0 Ω	
R927	ERD25TJ122	CARBON	0.25W	5%	1K2 Ω	
R928	ERD25TJ5R6	CARBON	0.25W	5%	5R6 Ω	
R929	ERDS1FYJ471	CARBON	0.5W	5%	470 Ω	△
R931	ERDS1FYJ390	CARBON	0.5W	5%	39 Ω	△
R935	ERQ14AJW3R9	FUSIBLE	0.25W	5%	3R9 Ω	△
R936	ERQ1CJP102	FUSIBLE	1W	5%	1K Ω	△
R937	ERQ14AJW100	FUSIBLE	0.25W	5%	10 Ω	△
R938	ERD25TJ122	CARBON	0.25W	5%	1K2 Ω	
R941	ERD25TJ5R6	CARBON	0.25W	5%	5R6 Ω	
R1011	ERD25TJ101	CARBON	0.25W	5%	100 Ω	
R1012	ERD25TJ101	CARBON	0.25W	5%	100 Ω	
R1013	ERD25TJ471	CARBON	0.25W	5%	470 Ω	
R1015	ERD25TJ103	CARBON	0.25W	5%	10K Ω	
R1071	ERD25TJ103	CARBON	0.25W	5%	10K Ω	
R1072	ERD25TJ222	CARBON	0.25W	5%	2K2 Ω	
R1073	ERD25TJ222	CARBON	0.25W	5%	2K2 Ω	
R1074	ERD25TJ332	CARBON	0.25W	5%	3K3 Ω	
R1075	ERD25TJ512	CARBON	0.25W	5%	5K1 Ω	
R1076	ERD25TJ912	CARBON	0.25W	5%	9K1 Ω	
R1101	ERJ6GEYJ101	S.M.CARB	0.1W	5%	100 Ω	
R1103	ERJ6GEYJ472	S.M.CARB	0.1W	5%	4K7 Ω	
R1104	ERJ6GEYJ101	S.M.CARB	0.1W	5%	100 Ω	
R1105	ERJ6GEYJ101	S.M.CARB	0.1W	5%	100 Ω	
R1106	ERJ6GEYJ472	S.M.CARB	0.1W	5%	4K7 Ω	
R1107	ERJ6GEYJ101	S.M.CARB	0.1W	5%	100 Ω	
R1108	ERJ6GEYJ472	S.M.CARB	0.1W	5%	4K7 Ω	
R1109	ERJ6GEYJ101	S.M.CARB	0.1W	5%	100 Ω	
R1110	ERJ6GEYJ101	S.M.CARB	0.1W	5%	100 Ω	
R1111	ERJ6GEYJ101	S.M.CARB	0.1W	5%	100 Ω	
R1113	ERJ6GEYJ101	S.M.CARB	0.1W	5%	100 Ω	
R1114	ERJ6GEYJ101	S.M.CARB	0.1W	5%	100 Ω	
R1116	ERJ6GEYJ101	S.M.CARB	0.1W	5%	100 Ω	
R1117	ERJ6GEYJ332	S.M.CARB	0.1W	5%	3K3 Ω	
R1118	ERJ6GEYJ332	S.M.CARB	0.1W	5%	3K3 Ω	
R1119	ERJ6GEYJ332	S.M.CARB	0.1W	5%	3K3 Ω	
R1120	ERJ6GEYJ332	S.M.CARB	0.1W	5%	3K3 Ω	
R1121	ERJ6GEYJ472	S.M.CARB	0.1W	5%	4K7 Ω	
R1122	ERJ6GEYJ472	S.M.CARB	0.1W	5%	4K7 Ω	
R1123	ERJ6GEYJ823	S.M.CARB	0.1W	5%	82K Ω	
R1124	ERJ6GEYJ101	S.M.CARB	0.1W	5%	100 Ω	
R1125	ERJ6GEYJ101	S.M.CARB	0.1W	5%	100 Ω	
R1126	ERJ6GEYJ101	S.M.CARB	0.1W	5%	100 Ω	
R1127	ERJ6GEYJ101	S.M.CARB	0.1W	5%	100 Ω	
R1128	ERJ6GEYJ472	S.M.CARB	0.1W	5%	4K7 Ω	
R1129	ERJ6GEYJ472	S.M.CARB	0.1W	5%	4K7 Ω	
R1130	ERJ6GEYJ104	S.M.CARB	0.1W	5%	100K Ω	
R1131	ERJ6GEYJ101	S.M.CARB	0.1W	5%	100 Ω	
R1132	ERJ6GEYJ101	S.M.CARB	0.1W	5%	100 Ω	
R1133	ERJ6GEYJ101	S.M.CARB	0.1W	5%	100 Ω	
R1134	ERJ6GEYJ101	S.M.CARB	0.1W	5%	100 Ω	
R1135	ERJ6GEYJ225	S.M.CARB	0.1W	5%	2M2 Ω	
R1138	ERJ6GEYJ273	S.M.CARB	0.1W	5%	27K Ω	
R1139	ERJ6GEYJ472	S.M.CARB	0.1W	5%	4K7 Ω	
R1141	ERJ6GEYJ103	S.M.CARB	0.1W	5%	10K Ω	

Cct Ref	Parts Number	Description				
R1142	ERJ6GEYJ103	S.M.CARB	0.1W	5%	10K Ω	
R1143	ERJ6GEYJ101	S.M.CARB	0.1W	5%	100 Ω	
R1144	ERJ6GEYJ473	S.M.CARB	0.1W	5%	47K Ω	
R1145	ERJ6GEYJ472	S.M.CARB	0.1W	5%	4K7 Ω	
R1146	ERJ6GEYJ101	S.M.CARB	0.1W	5%	100 Ω	
R1147	ERJ6GEYJ223	S.M.CARB	0.1W	5%	22K Ω	
R1148	ERJ6GEYJ104	S.M.CARB	0.1W	5%	100K Ω	
R1149	ERJ6GEYJ104	S.M.CARB	0.1W	5%	100K Ω	
R1150	ERJ6GEYJ104	S.M.CARB	0.1W	5%	100K Ω	
R1151	ERJ6GEYJ103	S.M.CARB	0.1W	5%	10K Ω	
R1152	ERJ6GEYJ224	S.M.CARB	0.1W	5%	220K Ω	
R1153	ERJ6GEYJ273	S.M.CARB	0.1W	5%	27K Ω	
R1154	ERJ6GEYJ221	S.M.CARB	0.1W	5%	220 Ω	
R1155	ERJ6GEYJ474	S.M.CARB	0.1W	5%	470K Ω	
R1156	ERJ6GEY0R00	S.M.CARB	0.1W	5%	0 Ω	
R1157	ERJ6GEYJ100	S.M.CARB	0.1W	5%	10 Ω	
R1158	ERJ6GEYJ472	S.M.CARB	0.1W	5%	4K7 Ω	
R1160	ERJ6GEY0R00	S.M.CARB	0.1W	5%	0 Ω	
R1161	ERJ6GEYJ392	S.M.CARB	0.1W	5%	3K9 Ω	
R1162	ERJ6GEYJ102	S.M.CARB	0.1W	5%	1K Ω	
R1163	ERJ6GEYJ103	S.M.CARB	0.1W	5%	10K Ω	
R1164	ERJ6GEYJ103	S.M.CARB	0.1W	5%	10K Ω	
R1165	ERJ6GEYJ103	S.M.CARB	0.1W	5%	10K Ω	
R1166	ERJ6GEYJ683	S.M.CARB	0.1W	5%	68K Ω	
R1167	ERJ6GEYJ103	S.M.CARB	0.1W	5%	10K Ω	
R1168	ERJ6GEYJ103	S.M.CARB	0.1W	5%	10K Ω	
R1169	ERJ6GEYJ103	S.M.CARB	0.1W	5%	10K Ω	
R1170	ERJ6GEYJ472	S.M.CARB	0.1W	5%	4K7 Ω	
R1171	ERJ6GEYJ472	S.M.CARB	0.1W	5%	4K7 Ω	
R1172	ERJ6GEYJ821	S.M.CARB	0.1W	5%	820 Ω	
R1173	ERJ6GEYJ681	S.M.CARB	0.1W	5%	680 Ω	
R1174	ERJ6GEYJ681	S.M.CARB	0.1W	5%	680 Ω	
R1175	ERJ6GEYJ101	S.M.CARB	0.1W	5%	100 Ω	
R1176	ERJ6GEYJ101	S.M.CARB	0.1W	5%	100 Ω	
R1177	ERJ6GEYJ103	S.M.CARB	0.1W	5%	10K Ω	
R1178	ERJ6GEYJ103	S.M.CARB	0.1W	5%	10K Ω	
R1179	ERJ6GEYJ101	S.M.CARB	0.1W	5%	100 Ω	
R1180	ERJ6GEYJ472	S.M.CARB	0.1W	5%	4K7 Ω	
R1181	ERJ6GEYJ101	S.M.CARB	0.1W	5%	100 Ω	
R1182	ERJ6GEYJ472	S.M.CARB	0.1W	5%	4K7 Ω	
R1183	ERJ6GEYJ472	S.M.CARB	0.1W	5%	4K7 Ω	
R1184	ERJ6GEYJ101	S.M.CARB	0.1W	5%	100 Ω	
R1186	ERJ6GEYJ103	S.M.CARB	0.1W	5%	10K Ω	
R1187	ERJ6GEYJ103	S.M.CARB	0.1W	5%	10K Ω	
R1188	ERJ6GEYJ472	S.M.CARB	0.1W	5%	4K7 Ω	
R1189	ERJ6GEYJ101	S.M.CARB	0.1W	5%	100 Ω	
R1190	ERJ6GEYJ472	S.M.CARB	0.1W	5%	4K7 Ω	
R1194	ERJ6GEYJ681	S.M.CARB	0.1W	5%	680 Ω	
R1195	ERJ6GEYJ103	S.M.CARB	0.1W	5%	10K Ω	
R1200	ERJ6GEYJ472	S.M.CARB	0.1W	5%	4K7 Ω	
R1237	ERJ6GEY0R00	S.M.CARB	0.1W	5%	0 Ω	
R1238	ERJ6GEYJ102	S.M.CARB	0.1W	5%	1K Ω	
R1239	ERJ6GEYJ560	S.M.CARB	0.1W	5%	56 Ω	
R1501	ERJ6GEY0R00	S.M.CARB	0.1W	5%	0 Ω	
R1502	ERJ6GEYJ151	S.M.CARB	0.1W	5%	150 Ω	
R1503	ERJ6GEYJ332	S.M.CARB	0.1W	5%	3K3 Ω	
R1504	ERJ6GEYJ151	S.M.CARB	0.1W	5%	150 Ω	
R1505	ERJ6GEYJ471	S.M.CARB	0.1W	5%	470 Ω	
R1506	ERJ6GEYJ271	S.M.CARB	0.1W	5%	270 Ω	
R1507	ERJ6GEYJ102	S.M.CARB	0.1W	5%	1K Ω	
R1508	ERJ6GEYJ471	S.M.CARB	0.1W	5%	470 Ω	
R1509	ERJ6GEYJ471	S.M.CARB	0.1W	5%	470 Ω	
R1510	ERJ6GEYJ8R2	S.M. CAR	0.1W	5%	8R2 Ω	
R1511	ERJ6GEYJ101	S.M.CARB	0.1W	5%	100 Ω	
R1513	ERJ6GEYJ101	S.M.CARB	0.1W	5%	100 Ω	
R1514	ERJ6GEYJ180	S.M.CARB	0.1W	5%	18 Ω	

Cct Ref	Parts Number	Description				
R1515	ERJ6GEYJ101	S.M.CARB	0.1W	5%	100 Ω	
R1517	ERJ6GEYJ180	S.M.CARB	0.1W	5%	18 Ω	
R1518	ERJ6GEYJ180	S.M.CARB	0.1W	5%	18 Ω	
R1519	ERJ6GEYJ561	S.M.CARB	0.1W	5%	560 Ω	
R1520	ERJ6GEYJ471	S.M.CARB	0.1W	5%	470 Ω	
R1521	ERJ6GEYJ820	S.M.CARB	0.1W	5%	82 Ω	
R1522	ERJ6GEYJ103	S.M.CARB	0.1W	5%	10K Ω	
R1523	ERJ6GEYJ390	S.M.CARB	0.1W	5%	39 Ω	
R1524	ERJ6GEYJ560	S.M.CARB	0.1W	5%	56 Ω	
R1525	ERJ6GEYJ271	S.M.CARB	0.1W	5%	270 Ω	
R1526	ERJ6GEY0R00	S.M.CARB	0.1W	5%	0 Ω	
R1527	ERJ6GEYJ100	S.M.CARB	0.1W	5%	10 Ω	
R1528	ERJ6GEYJ151	S.M.CARB	0.1W	5%	150 Ω	
R1530	ERJ6GEYJ560	S.M.CARB	0.1W	5%	56 Ω	
R1531	ERJ6GEYJ151	S.M.CARB	0.1W	5%	150 Ω	
R1532	ERJ6GEYJ151	S.M.CARB	0.1W	5%	150 Ω	
R1533	ERJ6GEYJ181	S.M.CARB	0.1W	5%	180 Ω	
R1534	ERJ6GEYJ272	S.M.CARB	0.1W	5%	2K7 Ω	
R1535	ERJ6GEYJ103	S.M.CARB	0.1W	5%	10K Ω	
R1536	ERJ6GEYJ470	S.M.CARB	0.1W	5%	47 Ω	
R1537	ERJ6GEYJ103	S.M.CARB	0.1W	5%	10K Ω	
R1538	ERJ6GEYJ181	S.M.CARB	0.1W	5%	180 Ω	
R1540	ERJ6GEYJ102	S.M.CARB	0.1W	5%	1K Ω	
R1541	ERJ6GEYJ102	S.M.CARB	0.1W	5%	1K Ω	
R1542	ERJ6GEYJ151	S.M.CARB	0.1W	5%	150 Ω	
R1543	ERJ6GEYJ103	S.M.CARB	0.1W	5%	10K Ω	
R1544	ERJ6GEYJ561	S.M.CARB	0.1W	5%	560 Ω	
R1545	ERJ6ENF3600	S.M. CAR	0.1W	5%	36 Ω	
R1546	ERJ6GEYJ561	S.M.CARB	0.1W	5%	560 Ω	
R1547	ERJ6GEYJ103	S.M.CARB	0.1W	5%	10K Ω	
R1548	ERJ6GEYJ221	S.M.CARB	0.1W	5%	220 Ω	
R1550	ERJ6GEYJ103	S.M.CARB	0.1W	5%	10K Ω	
R1551	ERJ6GEYJ271	S.M.CARB	0.1W	5%	270 Ω	
R1552	ERJ6GEYJ103	S.M.CARB	0.1W	5%	10K Ω	
R1553	ERJ6GEYJ750	S.M.CARB	0.1W	5%	75 Ω	
R1554	ERJ6GEYJ101	S.M.CARB	0.1W	5%	100 Ω	
R1555	ERJ6GEYJ101	S.M.CARB	0.1W	5%	100 Ω	
R1556	ERJ6GEYJ101	S.M.CARB	0.1W	5%	100 Ω	
R1559	ERJ6ENF2200	S.M. CAR	0.1W	5%	22 Ω	
R1560	ERJ6GEYJ560	S.M.CARB	0.1W	5%	56 Ω	
R1561	ERJ6GEY0R00	S.M.CARB	0.1W	5%	0 Ω	
R1562	ERJ6ENF4750	S.M. CAR	0.1W	5%	75 Ω	
R1563	ERJ6GEYJ271	S.M.CARB	0.1W	5%	270 Ω	
R1564	ERJ6ENF2200	S.M. CAR	0.1W	5%	22 Ω	
R1565	ERJ6GEYJ820	S.M.CARB	0.1W	5%	82 Ω	
R1566	ERJ6GEYJ331	S.M.CARB	0.1W	5%	330 Ω	
R1567	ERJ6ENF1500	S.M. CAR	0.1W	5%	15 Ω	
R1568	ERJ6ENF1500	S.M. CAR	0.1W	5%	15 Ω	
R1569	ERJ6ENF1500	S.M. CAR	0.1W	5%	15 Ω	
R1570	ERJ6ENF2701	S.M.CARB	0.1W	5%	27 Ω	
R1571	ERJ6GEYJ103	S.M.CARB	0.1W	5%	10K Ω	
R1572	ERJ6GEYJ103	S.M.CARB	0.1W	5%	10K Ω	
R1573	ERJ6ENF1500	S.M. CAR	0.1W	5%	15 Ω	
R1574	ERJ6GEYJ560	S.M.CARB	0.1W	5%	56 Ω	
R1575	ERJ6GEYJ102	S.M.CARB	0.1W	5%	1K Ω	
R1576	ERJ6GEYJ102	S.M.CARB	0.1W	5%	1K Ω	
R1577	ERJ6GEYJ102	S.M.CARB	0.1W	5%	1K Ω	
R1578	ERJ6GEYJ301	S.M.CARB	0.1W	5%	300 Ω	
R1579	ERJ6GEYJ431	S.M.CARB	0.1W	5%	430 Ω	
R1580	ERJ6GEYJ511	S.M.CARB	0.1W	5%	510 Ω	
R1581	ERJ6GEYJ151	S.M.CARB	0.1W	5%	150 Ω	
R1582	ERJ6GEYJ103	S.M.CARB	0.1W	5%	10K Ω	
R1583	ERJ6GEYJ561	S.M.CARB	0.1W	5%	560 Ω	
R1584	ERJ6GEYJ561	S.M.CARB	0.1W	5%	560 Ω	
R1585	ERJ6GEYJ103	S.M.CARB	0.1W	5%	10K Ω	
R1586	ERJ6GEY0R00	S.M.CARB	0.1W	5%	0 Ω	

Cct Ref	Parts Number	Description			
R1587	ERJ6GEY0R00	S.M.CARB	0.1W	5%	0 Ω
R1588	ERJ6GEYJ221	S.M.CARB	0.1W	5%	220 Ω
R1589	ERJ6GEYJ152	S.M.CARB	0.1W	5%	1K5 Ω
R1590	ERJ6GEYJ101	S.M.CARB	0.1W	5%	100 Ω
R1591	ERJ6GEYJ103	S.M.CARB	0.1W	5%	10K Ω
R1592	ERJ6GEYJ101	S.M.CARB	0.1W	5%	100 Ω
R1593	ERJ6GEYJ101	S.M.CARB	0.1W	5%	100 Ω
R1594	ERJ6GEYJ101	S.M.CARB	0.1W	5%	100 Ω
R1595	ERJ6GEYJ101	S.M.CARB	0.1W	5%	100 Ω
R1598	ERJ6GEYJ101	S.M.CARB	0.1W	5%	100 Ω
R1599	ERJ6GEYJ101	S.M.CARB	0.1W	5%	100 Ω
R1600	ERJ6GEYJ103	S.M.CARB	0.1W	5%	10K Ω
R1603	ERJ6GEYJ101	S.M.CARB	0.1W	5%	100 Ω
R1604	ERJ6GEYJ820	S.M.CARB	0.1W	5%	82 Ω
R1605	ERJ6GEYJ183	S.M.CARB	0.1W	5%	18K Ω
R1606	ERJ6GEYJ273	S.M.CARB	0.1W	5%	27K Ω
R1607	ERJ6GEYJ101	S.M.CARB	0.1W	5%	100 Ω
R1609	ERJ6GEYJ103	S.M.CARB	0.1W	5%	10K Ω
R1610	ERJ6GEYJ101	S.M.CARB	0.1W	5%	100 Ω
R1611	ERJ6GEYJ101	S.M.CARB	0.1W	5%	100 Ω
R1613	ERJ6GEYJ102	S.M.CARB	0.1W	5%	1K Ω
R1614	ERJ6GEY0R00	S.M.CARB	0.1W	5%	0 Ω
R1615	ERJ6GEY0R00	S.M.CARB	0.1W	5%	0 Ω
R1616	ERJ6GEYJ101	S.M.CARB	0.1W	5%	100 Ω
R1617	ERJ6ENF1100	S.M. CAR	0.1W	5%	10 Ω
R1618	ERJ6GEYJ103	S.M.CARB	0.1W	5%	10K Ω
R1619	ERJ6GEYJ103	S.M.CARB	0.1W	5%	10K Ω
R1620	ERJ6GEYJ331	S.M.CARB	0.1W	5%	330 Ω
R1621	ERJ6GEYJ471	S.M.CARB	0.1W	5%	470 Ω
R1622	ERJ6GEYJ102	S.M.CARB	0.1W	5%	1K Ω
R1623	ERJ6GEYJ471	S.M.CARB	0.1W	5%	470 Ω
R1624	ERJ6GEYJ333	S.M.CARB	0.1W	5%	33K Ω
R1625	ERJ6GEYJ221	S.M.CARB	0.1W	5%	220 Ω
R1626	ERJ6GEYJ332	S.M.CARB	0.1W	5%	3K3 Ω
R1627	ERJ6GEYJ100	S.M.CARB	0.1W	5%	10 Ω
R1628	ERJ6GEY0R00	S.M.CARB	0.1W	5%	0 Ω
R1629	ERJ6GEYJ121	S.M.CARB	0.1W	5%	120 Ω
R1630	ERJ6GEYJ103	S.M.CARB	0.1W	5%	10K Ω
R1631	ERJ6ENF1500	S.M. CAR	0.1W	5%	15 Ω
R1632	ERJ6GEY0R00	S.M.CARB	0.1W	5%	0 Ω
R1633	ERJ6GEY0R00	S.M.CARB	0.1W	5%	0 Ω
R1634	ERJ6GEYJ101	S.M.CARB	0.1W	5%	100 Ω
R1635	ERJ6GEYJ271	S.M.CARB	0.1W	5%	270 Ω
R1636	ERJ6GEYJ101	S.M.CARB	0.1W	5%	100 Ω
R1637	ERJ6GEYJ271	S.M.CARB	0.1W	5%	270 Ω
R1639	ERJ6GEYJ331	S.M.CARB	0.1W	5%	330 Ω
R1640	ERJ6GEY0R00	S.M.CARB	0.1W	5%	0 Ω
R1641	ERJ6GEYJ473	S.M.CARB	0.1W	5%	47K Ω
R1642	ERJ6GEYJ183	S.M.CARB	0.1W	5%	18K Ω
R1643	ERJ6GEYJ473	S.M.CARB	0.1W	5%	47K Ω
R1644	ERJ6GEYJ183	S.M.CARB	0.1W	5%	18K Ω
R1645	ERJ6GEYJ473	S.M.CARB	0.1W	5%	47K Ω
R1646	ERJ6GEYJ183	S.M.CARB	0.1W	5%	18K Ω
R1660	ERJ6GEYJ103	S.M.CARB	0.1W	5%	10K Ω
R1661	ERJ6GEYJ471	S.M.CARB	0.1W	5%	470 Ω
R1662	ERJ6GEYJ223	S.M.CARB	0.1W	5%	22K Ω
R1663	ERJ6GEYJ331	S.M.CARB	0.1W	5%	330 Ω
R1664	ERJ6GEYJ103	S.M.CARB	0.1W	5%	10K Ω
R1665	ERJ6GEYJ471	S.M.CARB	0.1W	5%	470 Ω
R1666	ERJ6GEYJ223	S.M.CARB	0.1W	5%	22K Ω
R1667	ERJ6GEYJ331	S.M.CARB	0.1W	5%	330 Ω
R1668	ERJ6GEYJ103	S.M.CARB	0.1W	5%	10K Ω
R1669	ERJ6GEYJ471	S.M.CARB	0.1W	5%	470 Ω
R1670	ERJ6GEYJ223	S.M.CARB	0.1W	5%	22K Ω
R1671	ERJ6GEYJ331	S.M.CARB	0.1W	5%	330 Ω
R1672	ERJ6GEYJ471	S.M.CARB	0.1W	5%	470 Ω

Cct Ref	Parts Number	Description			
R1673	ERJ6GEY0R00	S.M.CARB	0.1W	5%	0 Ω
R1674	ERJ6GEY0R00	S.M.CARB	0.1W	5%	0 Ω
R1675	ERJ6GEY0R00	S.M.CARB	0.1W	5%	0 Ω
R1676	ERJ6GEYJ560	S.M.CARB	0.1W	5%	56 Ω
R1677	ERJ6ENF6800	S.M. CAR	0.1W	5%	80 Ω
R1678	ERJ6ENF1500	S.M. CAR	0.1W	5%	15 Ω
R1679	ERJ6ENF1500	S.M. CAR	0.1W	5%	15 Ω
R1680	ERJ6GEYJ271	S.M.CARB	0.1W	5%	270 Ω
R1681	ERJ6GEYJ271	S.M.CARB	0.1W	5%	270 Ω
R1682	ERJ6GEYJ271	S.M.CARB	0.1W	5%	270 Ω
R1683	ERJ6GEYJ271	S.M.CARB	0.1W	5%	270 Ω
R1684	ERJ6GEYJ271	S.M.CARB	0.1W	5%	270 Ω
R1685	ERQ14AJ100	FUSIBLE	0.25W	5%	10 Ω [△]
R1686	ERJ6GEYJ103	S.M.CARB	0.1W	5%	10K Ω
R1687	ERJ6GEYJ103	S.M.CARB	0.1W	5%	10K Ω
R1688	ERJ6GEYJ331	S.M.CARB	0.1W	5%	330 Ω
R1690	ERJ6GEYJ750	S.M.CARB	0.1W	5%	75 Ω
R1691	ERJ6GEYJ750	S.M.CARB	0.1W	5%	75 Ω
R1692	ERJ6GEYJ750	S.M.CARB	0.1W	5%	75 Ω
R2101	ERJ6GEYJ101	S.M.CARB	0.1W	5%	100 Ω
R2102	ERJ6GEYJ101	S.M.CARB	0.1W	5%	100 Ω
R2103	ERJ6GEY0R00	S.M.CARB	0.1W	5%	0 Ω
R2104	ERJ6GEY0R00	S.M.CARB	0.1W	5%	0 Ω
R2105	ERJ6GEYJ102	S.M.CARB	0.1W	5%	1K Ω
R2106	ERJ6GEYJ101	S.M.CARB	0.1W	5%	100 Ω
R2107	ERJ6GEYJ101	S.M.CARB	0.1W	5%	100 Ω
R2108	ERJ6GEYJ103	S.M.CARB	0.1W	5%	10K Ω
R2109	ERJ6GEYJ472	S.M.CARB	0.1W	5%	4K7 Ω
R2110	ERJ6GEYJ101	S.M.CARB	0.1W	5%	100 Ω
R2111	ERJ6GEYJ471	S.M.CARB	0.1W	5%	470 Ω
R2112	ERJ6GEYJ472	S.M.CARB	0.1W	5%	4K7 Ω
R2114	ERJ6GEYJ101	S.M.CARB	0.1W	5%	100 Ω
R2117	ERJ6GEYJ222	S.M.CARB	0.1W	5%	2K2 Ω
R2118	ERJ6GEYJ471	S.M.CARB	0.1W	5%	470 Ω
R2120	ERJ6GEYJ471	S.M.CARB	0.1W	5%	470 Ω
R2121	ERJ6GEYJ222	S.M.CARB	0.1W	5%	2K2 Ω
R2125	ERJ6GEYJ103	S.M.CARB	0.1W	5%	10K Ω
R2301	ERJ6GEYJ104	S.M.CARB	0.1W	5%	100K Ω
R2302	ERJ6GEYJ103	S.M.CARB	0.1W	5%	10K Ω
R2303	ERJ6GEYJ104	S.M.CARB	0.1W	5%	100K Ω
R2304	ERJ6GEYJ471	S.M.CARB	0.1W	5%	470 Ω
R2307	ERJ6GEYJ471	S.M.CARB	0.1W	5%	470 Ω
R2308	ERJ6GEYJ103	S.M.CARB	0.1W	5%	10K Ω
R2312	ERJ6GEYJ272	S.M.CARB	0.1W	5%	2K7 Ω
R2314	ERJ6GEYJ471	S.M.CARB	0.1W	5%	470 Ω
R2315	ERJ6GEYJ471	S.M.CARB	0.1W	5%	470 Ω
R2316	ERJ6GEYJ222	S.M.CARB	0.1W	5%	2K2 Ω
R2318	ERJ6GEYJ331	S.M.CARB	0.1W	5%	330 Ω
R2319	ERJ6GEYJ222	S.M.CARB	0.1W	5%	2K2 Ω
R2320	ERJ6GEYJ101	S.M.CARB	0.1W	5%	100 Ω
R2321	ERJ6GEYJ101	S.M.CARB	0.1W	5%	100 Ω
R2351	ERJ6GEYJ102	S.M.CARB	0.1W	5%	1K Ω
R2352	ERJ6GEYJ102	S.M.CARB	0.1W	5%	1K Ω
R2353	ERJ6GEYJ103	S.M.CARB	0.1W	5%	10K Ω
R2354	ERJ6GEYJ103	S.M.CARB	0.1W	5%	10K Ω
R2355	ERJ6GEYJ103	S.M.CARB	0.1W	5%	10K Ω
R2356	ERJ6GEYJ103	S.M.CARB	0.1W	5%	10K Ω
R2357	ERJ6GEYJ562	S.M.CARB	0.1W	5%	5K6 Ω
R2358	ERJ6GEYJ562	S.M.CARB	0.1W	5%	5K6 Ω
R2359	ERJ6GEYJ393	S.M.CARB	0.1W	5%	39K Ω
R2361	ERJ6GEYJ223	S.M.CARB	0.1W	5%	22K Ω
R2362	ERJ6GEYJ103	S.M.CARB	0.1W	5%	10K Ω
R2363	ERJ6GEYJ103	S.M.CARB	0.1W	5%	10K Ω
R2364	ERD25TJ101	CARBON	0.25W	5%	100 Ω
R2365	ERJ6GEYJ102	S.M.CARB	0.1W	5%	1K Ω
R2368	ERJ6GEYJ222	S.M.CARB	0.1W	5%	2K2 Ω

Cct Ref	Parts Number	Description				
R2369	ERJ6GEYJ222	S.M.CARB	0.1W	5%	2K2 Ω	
R2370	ERJ6GEYJ103	S.M.CARB	0.1W	5%	10K Ω	
R2371	ERJ6GEYJ103	S.M.CARB	0.1W	5%	10K Ω	
R2372	ERJ6GEYJ562	S.M.CARB	0.1W	5%	5K6 Ω	
R2373	ERJ6GEYJ562	S.M.CARB	0.1W	5%	5K6 Ω	
R2376	ERJ6GEYJ103	S.M.CARB	0.1W	5%	10K Ω	
R2377	ERJ6GEYJ103	S.M.CARB	0.1W	5%	10K Ω	
R2459	ERJ6GEY0R00	S.M.CARB	0.1W	5%	0 Ω	
R2460	ERJ6GEY0R00	S.M.CARB	0.1W	5%	0 Ω	
R2474	ERJ6GEYJ101	S.M.CARB	0.1W	5%	100 Ω	
R2475	ERJ6GEYJ101	S.M.CARB	0.1W	5%	100 Ω	
R3005	ERJ6GEYJ104	S.M.CARB	0.1W	5%	100K Ω	
R3006	ERJ6GEYJ221	S.M.CARB	0.1W	5%	220 Ω	
R3007	ERJ6GEY0R00	S.M.CARB	0.1W	5%	0 Ω	
R3008	ERJ6GEYJ470	S.M.CARB	0.1W	5%	47 Ω	
R3009	ERJ6GEYJ470	S.M.CARB	0.1W	5%	47 Ω	
R3010	ERJ6GEYJ104	S.M.CARB	0.1W	5%	100K Ω	
R3012	ERJ6GEYJ104	S.M.CARB	0.1W	5%	100K Ω	
R3013	ERJ6GEYJ101	S.M.CARB	0.1W	5%	100 Ω	
R3014	ERJ6GEYJ101	S.M.CARB	0.1W	5%	100 Ω	
R3015	ERJ6GEYJ470	S.M.CARB	0.1W	5%	47 Ω	
R3016	ERJ6GEYJ121	S.M.CARB	0.1W	5%	120 Ω	
R3017	ERJ6GEYJ390	S.M.CARB	0.1W	5%	39 Ω	
R3018	ERJ6GEYJ101	S.M.CARB	0.1W	5%	100 Ω	
R3019	ERJ6GEYJ101	S.M.CARB	0.1W	5%	100 Ω	
R3020	ERJ6GEYJ101	S.M.CARB	0.1W	5%	100 Ω	
R3021	ERJ6GEYJ681	S.M.CARB	0.1W	5%	680 Ω	
R3022	ERJ6GEYJ680	S.M.CARB	0.1W	5%	68 Ω	
R3023	ERQ14AJ390	FUSIBLE	0.25W	5%	39 Ω	△
R3024	ERJ6GEYJ683	S.M.CARB	0.1W	5%	68K Ω	
R3025	ERJ6GEYJ153	S.M.CARB	0.1W	5%	15K Ω	
R3026	ERJ6GEYJ221	S.M.CARB	0.1W	5%	220 Ω	
R3027	ERJ6GEYJ100	S.M.CARB	0.1W	5%	10 Ω	
R3028	ERJ6GEYJ681	S.M.CARB	0.1W	5%	680 Ω	
R3029	ERJ6GEYJ100	S.M.CARB	0.1W	5%	10 Ω	
R3030	ERJ6GEYJ153	S.M.CARB	0.1W	5%	15K Ω	
R3031	ERJ6GEYJ472	S.M.CARB	0.1W	5%	4K7 Ω	
R3033	ERJ6GEYJ332	S.M.CARB	0.1W	5%	3K3 Ω	
R3034	ERJ6GEYJ332	S.M.CARB	0.1W	5%	3K3 Ω	
R3035	ERJ6GEYJ103	S.M.CARB	0.1W	5%	10K Ω	
R3036	ERJ6GEYJ101	S.M.CARB	0.1W	5%	100 Ω	
R3037	ERJ6GEYJ103	S.M.CARB	0.1W	5%	10K Ω	
R3038	ERJ6GEYJ332	S.M.CARB	0.1W	5%	3K3 Ω	
R3039	ERJ6GEYJ332	S.M.CARB	0.1W	5%	3K3 Ω	
R3040	ERJ6GEYJ101	S.M.CARB	0.1W	5%	100 Ω	
R3043	ERJ6GEYJ471	S.M.CARB	0.1W	5%	470 Ω	
R3045	ERJ6GEY0R00	S.M.CARB	0.1W	5%	0 Ω	
R3046	ERJ6GEYJ102	S.M.CARB	0.1W	5%	1K Ω	
R3047	ERJ6GEY0R00	S.M.CARB	0.1W	5%	0 Ω	
R3048	ERJ6GEYJ102	S.M.CARB	0.1W	5%	1K Ω	
R3053	ERJ6GEYJ220	S.M.CARB	0.1W	5%	22 Ω	
R3057	ERJ6GEYJ151	S.M.CARB	0.1W	5%	150 Ω	
R3058	ERJ6GEYJ104	S.M.CARB	0.1W	5%	100K Ω	
R3059	ERJ6GEYJ102	S.M.CARB	0.1W	5%	1K Ω	
R3060	ERJ6GEYJ471	S.M.CARB	0.1W	5%	470 Ω	
R3061	ERJ6GEYJ562	S.M.CARB	0.1W	5%	5K6 Ω	
R3062	ERJ6GEYJ562	S.M.CARB	0.1W	5%	5K6 Ω	
R3063	ERJ6GEYJ222	S.M.CARB	0.1W	5%	2K2 Ω	
R3064	ERJ6GEYJ272	S.M.CARB	0.1W	5%	2K7 Ω	
R3065	ERJ6GEYJ333	S.M.CARB	0.1W	5%	33K Ω	
R3066	ERJ6GEYJ471	S.M.CARB	0.1W	5%	470 Ω	
R3067	ERJ6GEYJ102	S.M.CARB	0.1W	5%	1K Ω	
R3068	ERJ6GEYJ563	S.M.CARB	0.1W	5%	56K Ω	
R3069	ERJ6GEYJ183	S.M.CARB	0.1W	5%	18K Ω	
R3070	ERJ6GEYJ102	S.M.CARB	0.1W	5%	1K Ω	
R3071	ERJ6GEYJ621	S.M. CAR	0.1W	5%	620 Ω	

Cct Ref	Parts Number	Description				
R3072	ERJ6GEYJ103	S.M.CARB	0.1W	5%	10K Ω	
R3073	ERJ6GEYJ393	S.M.CARB	0.1W	5%	39K Ω	
R3075	ERJ6GEYJ472	S.M.CARB	0.1W	5%	4K7 Ω	
R3076	ERJ6GEYJ331	S.M.CARB	0.1W	5%	330 Ω	
R3077	ERJ6GEYJ101	S.M.CARB	0.1W	5%	100 Ω	
R3078	ERJ6GEY0R00	S.M.CARB	0.1W	5%	0 Ω	
R3079	ERJ6GEYJ101	S.M.CARB	0.1W	5%	100 Ω	
R3080	ERJ6GEYJ101	S.M.CARB	0.1W	5%	100 Ω	
R3081	ERJ6GEYJ101	S.M.CARB	0.1W	5%	100 Ω	
R3082	ERJ6GEYJ101	S.M.CARB	0.1W	5%	100 Ω	
R3087	ERJ6GEYJ750	S.M.CARB	0.1W	5%	75 Ω	
R3113	ERJ6GEYJ101	S.M.CARB	0.1W	5%	100 Ω	
R3114	ERJ6GEYJ101	S.M.CARB	0.1W	5%	100 Ω	
R3125	ERJ6GEYJ681	S.M.CARB	0.1W	5%	680 Ω	
R3126	ERJ6GEYJ681	S.M.CARB	0.1W	5%	680 Ω	
R3281	ERD25TJ750	CARBON	0.25W	5%	75 Ω	
R3282	ERD25TJ750	CARBON	0.25W	5%	75 Ω	
R3284	ERD25TJ102	CARBON	0.25W	5%	1K Ω	
R3285	ERD25TJ102	CARBON	0.25W	5%	1K Ω	
R3351	ERJ6GEYJ220	S.M.CARB	0.1W	5%	22 Ω	
R3352	ERJ6GEYJ472	S.M.CARB	0.1W	5%	4K7 Ω	
R3353	ERJ6GEYJ474	S.M.CARB	0.1W	5%	470K Ω	
R3354	ERJ6GEYJ102	S.M.CARB	0.1W	5%	1K Ω	
R3355	ERJ6GEYJ391	S.M.CARB	0.1W	5%	390 Ω	
R3356	ERJ6GEYJ682	S.M.CARB	0.1W	5%	6K8 Ω	
R3357	ERJ6GEYJ682	S.M.CARB	0.1W	5%	6K8 Ω	
R3358	ERJ6GEYJ682	S.M.CARB	0.1W	5%	6K8 Ω	
R3360	ERDS1TJ471	CARBON	0.5W	5%	470 Ω	
R3361	ERO50PKF1133	METAL	0.5W	5%	110K Ω	△
R3401	ERJ6GEYJ101	S.M.CARB	0.1W	5%	100 Ω	
R3402	ERJ6GEYJ101	S.M.CARB	0.1W	5%	100 Ω	
R3403	ERJ6GEYJ333	S.M.CARB	0.1W	5%	33K Ω	
R3404	ERJ6GEYJ333	S.M.CARB	0.1W	5%	33K Ω	
R3405	ERJ6GEYJ102	S.M.CARB	0.1W	5%	1K Ω	
R3406	ERJ6GEYJ102	S.M.CARB	0.1W	5%	1K Ω	
R3407	ERJ6GEYJ153	S.M.CARB	0.1W	5%	15K Ω	
R3408	ERJ6GEYJ102	S.M.CARB	0.1W	5%	1K Ω	
R3409	ERJ6GEYJ102	S.M.CARB	0.1W	5%	1K Ω	
R3410	ERJ6GEYJ104	S.M.CARB	0.1W	5%	100K Ω	
R3412	ERJ6GEYJ102	S.M.CARB	0.1W	5%	1K Ω	
R3413	ERJ6GEYJ102	S.M.CARB	0.1W	5%	1K Ω	
R3414	ERJ6GEYJ750	S.M.CARB	0.1W	5%	75 Ω	
R3415	ERJ6GEYJ104	S.M.CARB	0.1W	5%	100K Ω	
R3416	ERJ6GEYJ333	S.M.CARB	0.1W	5%	33K Ω	
R3417	ERJ6GEYJ104	S.M.CARB	0.1W	5%	100K Ω	
R3418	ERJ6GEYJ104	S.M.CARB	0.1W	5%	100K Ω	
R3419	ERJ6GEYJ333	S.M.CARB	0.1W	5%	33K Ω	
R3420	ERJ6GEYJ750	S.M.CARB	0.1W	5%	75 Ω	
R3421	ERJ6GEYJ750	S.M.CARB	0.1W	5%	75 Ω	
R3422	ERJ6GEYJ153	S.M.CARB	0.1W	5%	15K Ω	
R3423	ERJ6GEYJ470	S.M.CARB	0.1W	5%	47 Ω	
R3424	ERJ6GEYJ101	S.M.CARB	0.1W	5%	100 Ω	
R3425	ERJ6GEYJ221	S.M.CARB	0.1W	5%	220 Ω	
R3426	ERJ6GEYJ680	S.M.CARB	0.1W	5%	68 Ω	
R3427	ERJ6GEYJ102	S.M.CARB	0.1W	5%	1K Ω	
R3428	ERJ6GEYJ680	S.M.CARB	0.1W	5%	68 Ω	
R3430	ERJ6GEYJ103	S.M.CARB	0.1W	5%	10K Ω	
R3433	ERJ6GEYJ332	S.M.CARB	0.1W	5%	3K3 Ω	
R3446	ERJ6GEYJ102	S.M.CARB	0.1W	5%	1K Ω	
R3447	ERJ6GEYJ102	S.M.CARB	0.1W	5%	1K Ω	
R3452	ERJ6GEYJ101	S.M.CARB	0.1W	5%	100 Ω	
R3453	ERJ6GEYJ101	S.M.CARB	0.1W	5%	100 Ω	
R3454	ERJ6GEYJ101	S.M.CARB	0.1W	5%	100 Ω	
R3455	ERJ6GEYJ101	S.M.CARB	0.1W	5%	100 Ω	
R3801	ERJ6GEYJ101	S.M.CARB	0.1W	5%	100 Ω	
R3802	ERJ6GEYJ221	S.M.CARB	0.1W	5%	220 Ω	

Cct Ref	Parts Number	Description				
R3803	ERG3FJ100	METAL	3W	5%	10 Ω	△
R3990	ERJ6GEYJ472	S.M.CARB	0.1W	5%	4K7 Ω	
R3991	ERJ6GEYJ103	S.M.CARB	0.1W	5%	10K Ω	
R3992	ERJ6GEYJ103	S.M.CARB	0.1W	5%	10K Ω	
R3993	ERJ6GEYJ103	S.M.CARB	0.1W	5%	10K Ω	
R3994	ERJ6GEYJ103	S.M.CARB	0.1W	5%	10K Ω	
CAPACITORS						
C002	ECA1HMR33GB	ELECT	50V		0.33μF	
C003	ECUV1H104ZFX	S.M. CAP	50V		100nF	
C004	ECUV1H104ZFX	S.M. CAP	50V		100nF	
C005	ECA1CM221GB	ELECT	16V		220μF	
C006	ECUV1H104ZFX	S.M. CAP	50V		100nF	
C007	ECUV1H104ZFX	S.M. CAP	50V		100nF	
C008	ECUV1H561JCX	S.M. CAP	50V		560pF	
C009	ECA1CM221GB	ELECT	16V		220μF	
C010	ECA1HM4R7GB	ELECT	50V		4.7μF	
C011	ECUV1H100DCX	S.M. CAP	50V		10pF	
C012	ECUV1H100DCX	S.M. CAP	50V		10pF	
C013	ECA1CM470GB	ELECT	16V		47μF	
C014	ECUV1H104ZFX	S.M. CAP	50V		100nF	
C015	ECUV1H104ZFX	S.M. CAP	50V		100nF	
C017	ECUV1H100DCX	S.M. CAP	50V		10pF	
C018	ECJ2VF1H104Z	ELECT	350V		100nF	
C019	ECJ2VF1H104Z	ELECT	350V		100nF	
C103	ECUV1H104ZFX	S.M. CAP	50V		100nF	
C104	ECJ2VF1H103Z	ELECT	350V		10nF	
C107	ECUV1H104ZFX	S.M. CAP	50V		100nF	
C108	ECUV1H104ZFX	S.M. CAP	50V		100nF	
C109	ECUV1C184KBX	S.M. CAP	16V		180nF	
C110	ECUV1H104ZFX	S.M. CAP	50V		100nF	
C111	ECUV1H104ZFX	S.M. CAP	50V		100nF	
C251	ECA1HM101GB	ELECT	50V		100μF	
C253	ECA1HM100GB	ELECT	50V		10μF	
C254	ECQM1H104J	FILM	50V		100nF	
C255	ECA1EHG101B	ELECT	50V		100nF	
C257	ECA1HM100GB	ELECT	50V		10μF	
C258	ECA1HM101GB	ELECT	50V		100μF	
C259	ECQM1H104J	FILM	50V		100nF	
C260	ECA1VM102GB	ELECT	35V		1nF	
C261	ECA1VM102GB	ELECT	35V		1nF	
C263	ECA1HM4R7GB	ELECT	50V		4.7μF	
C264	ECA1HM222E	ELECT	50V		2.2nF	
C266	ECA1HM4R7GB	ELECT	50V		4.7μF	
C267	ECQM1H224J	FILM	50V		220nF	
C268	ECQM1H224J	FILM	50V		220nF	
C269	ECA1HM470GB	ELECT	50V		47μF	
C270	ECQM1H224J	FILM	50V		220nF	
C271	ECQM1H224J	FILM	50V		220nF	
C277	ECUV1H102JCX	S.M. CAP	50V		1nF	
C278	ECUV1H102JCX	S.M. CAP	50V		1nF	
C352	ECUV1H224ZFX	S.M. CAP	50V		220nF	
C353	ECUV1H104KBX	S.M. CAP	50V		100nF	
C354	ECQM2104KZ	FILM	250V		100nF	
C355	ECKC2H102J	CERAMIC	500V		1nF	△
C362	ECUV1H224ZFX	S.M. CAP	50V		220nF	
C363	ECUV1H104KBX	S.M. CAP	50V		100nF	
C364	ECQM2104KZ	FILM	250V		100nF	
C365	ECKC2H102J	CERAMIC	500V		1nF	△
C372	ECUV1H224ZFX	S.M. CAP	50V		220nF	
C373	ECUV1H104KBX	S.M. CAP	50V		100nF	
C374	ECQM2104KZ	FILM	250V		100nF	
C375	ECKC2H102J	CERAMIC	500V		1nF	△
C381	ECA1HM101GB	ELECT	50V		100μF	
C382	ECA1CM471GB	ELECT	16V		470μF	
C383	ECUV1H103KBX	S.M. CAP	50V		10nF	
C384	ECQM2104KZ	FILM	250V		100nF	

Cct Ref	Parts Number	Description				
C385	ECA2EM220B	ELECT	250V		22μF	
C386	ECKC3D152J	CERAMIC	2KV		1.5nF	△
C387	ECUV1H681JCX	S.M. CAP	50V		680pF	
C395	ECQM1H104J	FILM	50V		100nF	
C396	ECJ2VF1H104Z	ELECT	350V		100nF	
C400	ECA1VM102GB	ELECT	35V		1nF	
C402	ECA1HM010GB	ELECT	50V		1μF	
C404	ECEA1HU471	ELECT	50V		470μF	
C405	ECA1EM102GB	ELECT	25V		100μF	
C407	ECQB1224KFW	FILM	100V		220nF	
C411	ECUV1H102KBX	S.M. CAP	50V		1nF	
C501	ECQM1H224J	FILM	50V		220nF	
C502	ECQM2104KZ	FILM	250V		100nF	
C503	ECKC2H102J	CERAMIC	500V		1nF	△
C504	ECQB1H223K	FILM	50V		22nF	
C505	ECA1EM222GB	ELECT	25V		2200μF	
C506	ECKC2H102J	CERAMIC	500V		1nF	△
C507	ECA1EM332E	ELECT	25V		3300μF	
C552	ECWH20392JVY	FILM	200V		39nF	
C553	ECQP1104JZW	FILM	100V		100nF	
C554	ECQB1H152K	FILM	50V		1.5nF	
C556	ECEA2CNR47SB	ELECT	160V		0.47μF	
C557	ECKC2H331J	CERAMIC	500V		330pF	△
C558	ECA2EM330B	ELECT	250V		33μF	
C559	ECKC2H103J	CERAMIC	50V		10nF	△
C563	ECWF2564JBB	FILM	200V		560nF	△
C564	EKC1H103JB	CERAMIC	50V		10nF	
C565	ECQP1823JZW	FILM	100V		82nF	
C572	ECWH20472JVVB	FILM	200V		4.7nF	
C573	ECQF4153JZH	FILM	400V		1.5nF	△
C581	ECQF4123JZH	FILM	400V		12nF	△
C584	ECKC3D221JB	CERAMIC	2KV		220pF	△
C602	ECUV1H104ZFX	S.M. CAP	50V		100nF	
C603	ECUV1H104ZFX	S.M. CAP	50V		100nF	
C604	ECUV1H470JCX	S.M. CAP	50V		47pF	
C605	ECA1CM221GB	ELECT	16V		220μF	
C606	ECA1AM332E	ELECT	10V		3300μF	
C607	ECUV1H104ZFX	S.M. CAP	50V		100nF	
C608	ECUV1H104ZFX	S.M. CAP	50V		100nF	
C609	ECA1HM3R3GB	ELECT	50V		3.3μF	
C610	ECUV1H104ZFX	S.M. CAP	50V		100nF	
C611	ECUV1H104ZFX	S.M. CAP	50V		100nF	
C612	ECUV1H104ZFX	S.M. CAP	50V		100nF	
C613	ECUV1H104ZFX	S.M. CAP	50V		100nF	
C614	ECUV1H104ZFX	S.M. CAP	50V		100nF	
C615	ECJ2VB1C104K	ELECT	350V		100nF	
C616	ECQM1H104J	FILM	50V		100nF	
C617	ECUV1H104ZFX	S.M. CAP	50V		100nF	
C618	ECUV1H104ZFX	S.M. CAP	50V		100nF	
C620	ECUV1H100DCX	S.M. CAP	50V		10pF	
C622	ECUV1H470JCX	S.M. CAP	50V		47pF	
C623	ECUV1H470JCX	S.M. CAP	50V		47pF	
C624	ECUV1H820JCX	S.M. CAP	50V		82pF	
C625	ECUV1H470JCX	S.M. CAP	50V		47pF	
C626	ECUV1H470JCX	S.M. CAP	50V		47pF	
C627	ECUV1H470JCX	S.M. CAP	50V		47pF	
C628	ECUV1H470JCX	S.M. CAP	50V		47pF	
C632	ECUV1H104ZFX	S.M. CAP	50V		100nF	
C633	ECUV1H104ZFX	S.M. CAP	50V		100nF	
C635	ECA1EM101GB	ELECT	25V		100μF	
C636	ECJ2VF1H103Z	ELECT	350V		10nF	
C637	ECUV1H470JCX	S.M. CAP	50V		47pF	
C638	ECUV1H270JCX	S.M. CAP	50V		27pF	
C639	ECUV1H104ZFX	S.M. CAP	50V		100nF	
C641	ECUV1H101JCX	S.M. CAP	50V		100pF	
C643	ECUV1H102KBX	S.M. CAP	50V		1nF	

Cct Ref	Parts Number	Description			
C644	ECQM1H104J	FILM	50V	100nF	
C645	ECQM1H104J	FILM	50V	100nF	
C646	ECUV1H103KBX	S.M. CAP	50V	10nF	
C651	ECUV1C224KBX	S.M. CAP	16V	220nF	
C701	ECQV1H105JZ	FILM	50V	1µF	
C702	ECKC2H102J	CERAMIC	500V	1nF	△
C806	ECQE6104K	FILM	600V	100nF	△
C807	ECQB1H473K	FILM	50V	47nF	
C808	ECQM1H334J	FILM	50V	330nF	
C809	ECQE2A474MWB	FILM	100V	470nF	
C811	ECQB1H104J	FILM	50V	100nF	
C812	ECQB1H562K	FILM	50V	5.6nF	
C813	ECKC2H472J	CERAMIC	500V	4.7nF	△
C814	ECKC2H472J	CERAMIC	500V	4.7nF	△
C815	ECA1CM331B	ELECT	16V	330µF	
C816	ECQB1H122J	FILM	50V	1.2nF	
C817	ECKC2H472J	CERAMIC	500V	4.7nF	△
C818	ECKC2H472J	CERAMIC	500V	4.7nF	△
C819	ECOS2WB221DB	ELECT	16V	220µF	
C820	ECOS2WB221DB	ELECT	16V	220µF	
C821	ECQB1H222J	FILM	50V	2.2nF	
C822	ECKC3D471JB	CERAMIC	2KV	470pF	△
C823	EEUFA1V221B	CERAMIC	35V	220µF	
C824	ECQB1H221KF3	FILM	50V	220µF	
C826	ECQB1H473K	FILM	50V	47nF	
C827	ECKCNS332J	CERAMIC	1.2KV	3.3nF	△
C830	ECQE6105JFW	FILM	600V	1µF	△
C831	ECKC3D471JB	CERAMIC	2KV	470pF	△
C833	ECQB1H682K	FILM	50V	6.8nF	
C835	ECQB1H332K	FILM	50V	3.3nF	
C842	222233510154	FILM	50V	100µF	
C843	ECQE2A474MWB	FILM	100V	470nF	
C847	ECEA1EN101UB	ELECT	25V	100µF	
C848	ECKC2H331J	CERAMIC	500V	330pF	△
C849	ECKC2H391J	CERAMIC	500V	390pF	△
C852	ECKC3D222JB	CERAMIC	2KV	390pF	△
C853	ECEA1CU332	ELECT	16V	390pF	
C854	ECA1EM221GB	ELECT	25V	390pF	
C855	ECEA1HU102	ELECT	50V	390pF	
C856	ECA1EM332E	ELECT	25V	390pF	
C857	ECA1EM471GB	ELECT	25V	470µF	
C858	ECOS2EA271BB	ELECT	250V	270µF	
C859	ECKC2H471J	CERAMIC	500V	470pF	△
C861	ECOS2EA221AB	ELECT	250V	220µF	
C863	ECA1EM332E	ELECT	25V	220µF	
C864	ECA0JM102GB	ELECT	6.3V	220µF	
C866	ECA1HM101GB	ELECT	50V	100µF	
C867	ECA1CM222E	ELECT	16V	2.2nF	
C868	ECA1CM100GB	ELECT	16V	10µF	
C869	ECA1HM101GB	ELECT	50V	100µF	
C871	ECA0JM102GB	ELECT	6.3V	100µF	
C872	ECA1CM222E	ELECT	16V	2.2nF	
C901	ECUV1H030CCX	S.M. CAP	50V	30pF	
C902	ECA1VM101GB	ELECT	35V	100µF	
C904	ECJ2VF1H103Z	ELECT	350V	10nF	
C906	ECUV1H680JCX	S.M. CAP	50V	68pF	
C907	ECUV1H121JCX	S.M. CAP	50V	120pF	
C908	ECUV1H151JCX	S.M. CAP	50V	150pF	
C909	ECKC2H472J	CERAMIC	500V	4.7nF	△
C910	ECKC2H472J	CERAMIC	500V	4.7nF	△
C911	ECUV1H151JCX	S.M. CAP	50V	150pF	
C912	ECA2EM220B	ELECT	250V	22µF	
C913	ECA1HM101GB	ELECT	50V	100µF	
C914	ECA1HM101GB	ELECT	50V	100µF	
C916	ECA2EM220B	ELECT	250V	22µF	
C917	ECA1HM100GB	ELECT	50V	10µF	

Cct Ref	Parts Number	Description			
C918	ECJ2VF1H103Z	ELECT	350V	10nF	
C919	ECCR2H270J	CERAMIC	500V	27pF	
C1011	ECKC1H101J	CERAMIC	50V	100pF	
C1012	ECA1VM470B	ELECT	35V	47µF	
C1013	ECKC1H103JB	CERAMIC	50V	10nF	
C1014	ECA1HM101GB	ELECT	50V	100µF	
C1101	ECUV1H104ZFX	S.M. CAP	50V	100nF	
C1102	ECUV1H101JCX	S.M. CAP	50V	100pF	
C1103	ECUV1H220JCX	S.M. CAP	50V	22pF	
C1104	ECUV1H220JCX	S.M. CAP	50V	22pF	
C1107	ECUV1H104ZFX	S.M. CAP	50V	100nF	
C1109	ECUV1C104KBX	S.M. CAP	16V	100nF	
C1113	ECUV1C104KBX	S.M. CAP	16V	100nF	
C1114	ECA1HM101GB	ELECT	50V	100µF	
C1116	ECUV1H560JCX	S.M. CAP	50V	56pF	
C1117	ECUV1H221JCX	S.M. CAP	50V	220pF	
C1118	ECJ3VB1C474K	ELECT	3.5KV	470nF	
C1120	ECUV1H104ZFX	S.M. CAP	50V	100nF	
C1121	ECUV1H472KBX	S.M. CAP	50V	4.7nF	
C1122	ECA1HM010GB	ELECT	50V	1µF	
C1123	ECUV1H104ZFX	S.M. CAP	50V	100nF	
C1124	ECUV1H101JCX	S.M. CAP	50V	100pF	
C1125	ECUV1H104ZFX	S.M. CAP	50V	100nF	
C1126	ECUV1H104ZFX	S.M. CAP	50V	100nF	
C1127	ECA1HM101GB	ELECT	50V	100µF	
C1128	ECUV1H104ZFX	S.M. CAP	50V	100nF	
C1129	ECA1HM101GB	ELECT	50V	100µF	
C1130	ECUV1H103KBX	S.M. CAP	50V	10nF	
C1131	ECUV1H221JCX	S.M. CAP	50V	220pF	
C1138	ECUV1H224ZFX	S.M. CAP	50V	220nF	
C1145	ECJ2VB1H333K	ELECT	350V	33nF	
C1147	ECA1CM331B	ELECT	16V	330µF	
C1148	ECUV1C224KBX	S.M. CAP	16V	220nF	
C1501	ECUV1H330JCX	S.M. CAP	50V	33pF	
C1502	ECUV1H471JCX	S.M. CAP	50V	470pF	
C1503	ECUV1H390JCX	S.M. CAP	50V	39pF	
C1504	ECUV1H680JCX	S.M. CAP	50V	68pF	
C1505	ECUV1H820JCX	S.M. CAP	50V	82pF	
C1506	ECUV1H331JCX	S.M. CAP	50V	330pF	
C1507	ECUV1H102KBX	S.M. CAP	50V	1nF	
C1508	ECEA1HN010UB	ELECT	50V	1µF	
C1509	ECUV1H104ZFX	S.M. CAP	50V	100nF	
C1510	ECA1HM101GB	ELECT	50V	100µF	
C1511	ECUV1H104ZFX	S.M. CAP	50V	100nF	
C1512	ECUV1H030CCX	S.M. CAP	50V	30pF	
C1513	ECA1HM100GB	ELECT	50V	10µF	
C1514	ECUV1H104ZFX	S.M. CAP	50V	100nF	
C1515	ECUV1H104ZFX	S.M. CAP	50V	100nF	
C1516	ECUV1H030CCX	S.M. CAP	50V	30pF	
C1517	ECUV1H473ZFX	S.M. CAP	50V	47nF	
C1518	ECUV1H104ZFX	S.M. CAP	50V	100nF	
C1519	ECA1HM101GB	ELECT	50V	100µF	
C1521	ECA1HM101GB	ELECT	50V	100µF	
C1522	ECUV1H104ZFX	S.M. CAP	50V	100nF	
C1523	ECUV1H104ZFX	S.M. CAP	50V	100nF	
C1524	ECA1VM470B	ELECT	35V	47µF	
C1525	ECUV1H104ZFX	S.M. CAP	50V	100nF	
C1527	ECUV1H104ZFX	S.M. CAP	50V	100nF	
C1528	ECUV1H104ZFX	S.M. CAP	50V	100nF	
C1529	ECUV1H104ZFX	S.M. CAP	50V	100nF	
C1530	ECUV1H104ZFX	S.M. CAP	50V	100nF	
C1532	ECUV1H104ZFX	S.M. CAP	50V	100nF	
C1533	ECUV1H104ZFX	S.M. CAP	50V	100nF	
C1534	ECUV1H104ZFX	S.M. CAP	50V	100nF	
C1535	ECUV1H104ZFX	S.M. CAP	50V	100nF	
C1536	ECUV1H104ZFX	S.M. CAP	50V	100nF	

Cct Ref	Parts Number	Description		
C1537	ECUV1H104ZFX	S.M. CAP	50V	100nF
C1538	EEUNA1E220B	CERAMIC	25V	22µF
C1539	ECUV1H104ZFX	S.M. CAP	50V	100nF
C1540	ECUV1H104ZFX	S.M. CAP	50V	100nF
C1541	ECUV1H104ZFX	S.M. CAP	50V	100nF
C1542	ECA1CM471GB	ELECT	16V	470µF
C1543	ECUV1H104ZFX	S.M. CAP	50V	100nF
C1544	EEUNA1E220B	CERAMIC	25V	22µF
C1545	ECUV1H104ZFX	S.M. CAP	50V	100nF
C1546	ECA1HM101GB	ELECT	50V	100µF
C1547	ECUV1H104ZFX	S.M. CAP	50V	100nF
C1548	ECUV1H104ZFX	S.M. CAP	50V	100nF
C1549	ECUV1H104ZFX	S.M. CAP	50V	100nF
C1550	ECUV1H104ZFX	S.M. CAP	50V	100nF
C1551	EEUNA1E220B	CERAMIC	25V	22µF
C1552	ECA1HM101GB	ELECT	50V	100µF
C1553	ECUV1H104ZFX	S.M. CAP	50V	100nF
C1554	ECUV1H104ZFX	S.M. CAP	50V	100nF
C1555	ECUV1H104ZFX	S.M. CAP	50V	100nF
C1556	ECA1HM101GB	ELECT	50V	100µF
C1557	ECUV1H104ZFX	S.M. CAP	50V	100nF
C1558	ECUV1H104ZFX	S.M. CAP	50V	100nF
C1559	ECUV1H104ZFX	S.M. CAP	50V	100nF
C1560	ECUV1H104ZFX	S.M. CAP	50V	100nF
C1561	ECUV1H104ZFX	S.M. CAP	50V	100nF
C1562	ECUV1H104ZFX	S.M. CAP	50V	100nF
C1563	ECA1HM101GB	ELECT	50V	100µF
C1564	ECUV1H104ZFX	S.M. CAP	50V	100nF
C1565	ECUV1H270JCX	S.M. CAP	50V	27pF
C1567	ECA1HM101GB	ELECT	50V	100µF
C1568	ECUV1H104ZFX	S.M. CAP	50V	100nF
C1569	ECUV1H104ZFX	S.M. CAP	50V	100nF
C1570	ECUV1H104ZFX	S.M. CAP	50V	100nF
C1571	ECA1CM471GB	ELECT	16V	470µF
C1572	ECUV1H104ZFX	S.M. CAP	50V	100nF
C1573	ECUV1H104ZFX	S.M. CAP	50V	100nF
C1574	ECUV1H104ZFX	S.M. CAP	50V	100nF
C1575	ECUV1H104ZFX	S.M. CAP	50V	100nF
C1576	ECUV1H104ZFX	S.M. CAP	50V	100nF
C1577	ECUV1H104ZFX	S.M. CAP	50V	100nF
C1578	ECUV1H104ZFX	S.M. CAP	50V	100nF
C1579	ECUV1H104ZFX	S.M. CAP	50V	100nF
C1580	ECUV1H104ZFX	S.M. CAP	50V	100nF
C1581	ECUV1H104ZFX	S.M. CAP	50V	100nF
C1582	ECUV1H104ZFX	S.M. CAP	50V	100nF
C1583	ECUV1H104ZFX	S.M. CAP	50V	100nF
C1584	ECUV1H104ZFX	S.M. CAP	50V	100nF
C1585	ECUV1H104ZFX	S.M. CAP	50V	100nF
C1586	ECUV1H104ZFX	S.M. CAP	50V	100nF
C1587	ECUV1H104ZFX	S.M. CAP	50V	100nF
C1588	ECUV1H104ZFX	S.M. CAP	50V	100nF
C1589	ECUV1H104ZFX	S.M. CAP	50V	100nF
C1590	ECUV1H104ZFX	S.M. CAP	50V	100nF
C1591	ECUV1H104ZFX	S.M. CAP	50V	100nF
C1592	ECA1CM221GB	ELECT	16V	220µF
C1593	ECA1CM221GB	ELECT	16V	220µF
C1594	ECUV1H104ZFX	S.M. CAP	50V	100nF
C1595	ECUV1H104ZFX	S.M. CAP	50V	100nF
C1596	ECUV1H104ZFX	S.M. CAP	50V	100nF
C1597	ECUV1H104ZFX	S.M. CAP	50V	100nF
C1598	ECUV1H104ZFX	S.M. CAP	50V	100nF
C1599	ECUV1H104ZFX	S.M. CAP	50V	100nF
C1600	ECUV1H104ZFX	S.M. CAP	50V	100nF
C1601	ECUV1H104ZFX	S.M. CAP	50V	100nF
C1602	ECUV1H104ZFX	S.M. CAP	50V	100nF
C1603	ECUV1H104ZFX	S.M. CAP	50V	100nF

Cct Ref	Parts Number	Description		
C1604	ECUV1H104ZFX	S.M. CAP	50V	100nF
C1605	ECUV1H104ZFX	S.M. CAP	50V	100nF
C1606	ECUV1H104ZFX	S.M. CAP	50V	100nF
C1607	ECUV1H104ZFX	S.M. CAP	50V	100nF
C1608	ECUV1H104ZFX	S.M. CAP	50V	100nF
C1609	ECUV1H104ZFX	S.M. CAP	50V	100nF
C1610	ECUV1H104ZFX	S.M. CAP	50V	100nF
C1611	ECA1CM471GB	ELECT	16V	470µF
C1612	ECUV1H104ZFX	S.M. CAP	50V	100nF
C1614	ECUV1H104ZFX	S.M. CAP	50V	100nF
C1615	ECUV1H104ZFX	S.M. CAP	50V	100nF
C1616	ECUV1H104ZFX	S.M. CAP	50V	100nF
C1617	ECUV1H104ZFX	S.M. CAP	50V	100nF
C1618	ECUV1H104ZFX	S.M. CAP	50V	100nF
C1619	ECUV1H104ZFX	S.M. CAP	50V	100nF
C1620	ECUV1H104ZFX	S.M. CAP	50V	100nF
C1621	ECUV1H104ZFX	S.M. CAP	50V	100nF
C1622	ECUV1H104ZFX	S.M. CAP	50V	100nF
C1623	ECUV1H104ZFX	S.M. CAP	50V	100nF
C1624	ECUV1H104ZFX	S.M. CAP	50V	100nF
C1625	ECUV1H104ZFX	S.M. CAP	50V	100nF
C1626	ECUV1H104ZFX	S.M. CAP	50V	100nF
C1627	ECUV1H104ZFX	S.M. CAP	50V	100nF
C1628	ECUV1H104ZFX	S.M. CAP	50V	100nF
C1629	ECUV1H104ZFX	S.M. CAP	50V	100nF
C1630	ECUV1H104ZFX	S.M. CAP	50V	100nF
C1631	ECUV1H104ZFX	S.M. CAP	50V	100nF
C1632	ECUV1H104ZFX	S.M. CAP	50V	100nF
C1633	ECUV1H104ZFX	S.M. CAP	50V	100nF
C1636	ECUV1H104ZFX	S.M. CAP	50V	100nF
C1637	ECUV1H104ZFX	S.M. CAP	50V	100nF
C1638	ECUV1H104ZFX	S.M. CAP	50V	100nF
C1639	ECUV1H104ZFX	S.M. CAP	50V	100nF
C1642	ECUV1H104ZFX	S.M. CAP	50V	100nF
C1643	ECUV1H104ZFX	S.M. CAP	50V	100nF
C1644	ECUV1H104ZFX	S.M. CAP	50V	100nF
C1645	ECUV1H104ZFX	S.M. CAP	50V	100nF
C1647	ECUV1H470JCX	S.M. CAP	50V	47pF
C1648	ECUV1H104ZFX	S.M. CAP	50V	100nF
C1649	ECA1HM101GB	ELECT	50V	100µF
C1650	ECUV1H104ZFX	S.M. CAP	50V	100nF
C1651	ECUV1H104ZFX	S.M. CAP	50V	100nF
C1652	ECA1HM101GB	ELECT	50V	100µF
C1653	ECUV1H104ZFX	S.M. CAP	50V	100nF
C1654	ECUV1H104ZFX	S.M. CAP	50V	100nF
C1655	ECA1VM470B	ELECT	35V	47µF
C1656	ECUV1H104ZFX	S.M. CAP	50V	100nF
C1658	ECUV1H104ZFX	S.M. CAP	50V	100nF
C1659	ECA1VM470B	ELECT	35V	47µF
C1660	ECUV1H104ZFX	S.M. CAP	50V	100nF
C1661	ECA1HM101GB	ELECT	50V	100µF
C1662	ECUV1H104ZFX	S.M. CAP	50V	100nF
C1663	ECUV1H560JCX	S.M. CAP	50V	56pF
C1664	ECUV1H104ZFX	S.M. CAP	50V	100nF
C1666	ECUV1H390JCX	S.M. CAP	50V	39pF
C1667	ECUV1H820JCX	S.M. CAP	50V	82pF
C1668	ECUV1H680JCX	S.M. CAP	50V	68pF
C1669	ECUV1H271JCX	S.M. CAP	50V	270pF
C1670	ECUV1H391JCX	S.M. CAP	50V	390pF
C1671	ECUV1H390JCX	S.M. CAP	50V	39pF
C1672	ECUV1H820JCX	S.M. CAP	50V	82pF
C1673	ECUV1H680JCX	S.M. CAP	50V	68pF
C1674	ECUV1H271JCX	S.M. CAP	50V	270pF
C1675	ECUV1H391JCX	S.M. CAP	50V	390pF
C1676	ECUV1H390JCX	S.M. CAP	50V	39pF
C1677	ECUV1H820JCX	S.M. CAP	50V	82pF

Cct Ref	Parts Number	Description		
C1678	ECUV1H680JCX	S.M. CAP	50V	68pF
C1679	ECUV1H271JCX	S.M. CAP	50V	270pF
C1680	ECUV1H391JCX	S.M. CAP	50V	390pF
C1681	ECUV1H820JCX	S.M. CAP	50V	82pF
C1682	ECUV1H104ZFX	S.M. CAP	50V	100nF
C1683	ECUV1H101JCX	S.M. CAP	50V	100pF
C1685	ECUV1H104ZFX	S.M. CAP	50V	100nF
C1686	ECUV1H101JCX	S.M. CAP	50V	100pF
C1688	ECUV1H104ZFX	S.M. CAP	50V	100nF
C1689	ECUV1H104ZFX	S.M. CAP	50V	100nF
C1690	ECJ2VF1C105Z	ELECT	350V	1µF
C1691	ECJ2VF1C105Z	ELECT	350V	1µF
C1692	EEUNA1E220B	CERAMIC	25V	22µF
C1693	ECA1HM101GB	ELECT	50V	100µF
C1695	ECUV1H221JCX	S.M. CAP	50V	220pF
C1696	EEUNA1E220B	CERAMIC	25V	22µF
C1697	EEUNA1E220B	CERAMIC	25V	22µF
C1698	EEUNA1E220B	CERAMIC	25V	22µF
C2103	ECUV1H391KBX	S.M. CAP	50V	390pF
C2104	ECUV1H102KBX	S.M. CAP	50V	1nF
C2105	ECUV1H102KBX	S.M. CAP	50V	1nF
C2106	ECUV1H102KBX	S.M. CAP	50V	1nF
C2107	ECUV1H102KBX	S.M. CAP	50V	1nF
C2108	ECUV1H102KBX	S.M. CAP	50V	1nF
C2109	ECUV1H102KBX	S.M. CAP	50V	1nF
C2110	ECUV1H102KBX	S.M. CAP	50V	1nF
C2111	ECA1CM100GB	ELECT	16V	10µF
C2112	ECUV1H104ZFX	S.M. CAP	50V	100nF
C2113	ECA1CM100GB	ELECT	16V	10µF
C2114	ECA1HM101GB	ELECT	50V	100µF
C2115	ECUV1H104ZFX	S.M. CAP	50V	100nF
C2116	ECUV1H102KBX	S.M. CAP	50V	1nF
C2117	ECUV1H471KBX	S.M. CAP	50V	470pF
C2118	ECA1HM3R3GB	ELECT	50V	3.3µF
C2119	ECUV1H471KBX	S.M. CAP	50V	470pF
C2120	ECUV1H104ZFX	S.M. CAP	50V	100nF
C2121	ECUV1H221JCX	S.M. CAP	50V	220pF
C2122	ECUV1H221JCX	S.M. CAP	50V	220pF
C2123	ECUV1H221JCX	S.M. CAP	50V	220pF
C2124	ECUV1H104ZFX	S.M. CAP	50V	100nF
C2125	ECA1CM100GB	ELECT	16V	10µF
C2126	ECUV1H221JCX	S.M. CAP	50V	220pF
C2127	ECUV1H104ZFX	S.M. CAP	50V	100nF
C2128	ECUV1H221JCX	S.M. CAP	50V	220pF
C2129	ECA1CM100GB	ELECT	16V	10µF
C2130	ECUV1H221JCX	S.M. CAP	50V	220pF
C2131	ECQM1H334J	FILM	50V	330nF
C2132	ECA1CM100GB	ELECT	16V	10µF
C2133	ECUV1H470JCX	S.M. CAP	50V	47pF
C2134	ECUV1H470JCX	S.M. CAP	50V	47pF
C2135	ECUV1H070DCX	S.M. CAP	50V	7pF
C2137	ECUV1H104ZFX	S.M. CAP	50V	100nF
C2138	ECUV1H010CCX	S.M. CAP	50V	1pF
C2139	ECUV1H010CCX	S.M. CAP	50V	1pF
C2141	ECUV1H560JCX	S.M. CAP	50V	56pF
C2142	ECA1CM100GB	ELECT	16V	10µF
C2144	ECUV1H560JCX	S.M. CAP	50V	56pF
C2146	ECA1CM100GB	ELECT	16V	10µF
C2147	ECUV1H103KBX	S.M. CAP	50V	10nF
C2148	ECUV1H103KBX	S.M. CAP	50V	10nF
C2301	ECA1CM470GB	ELECT	16V	47µF
C2302	ECA1CM470GB	ELECT	16V	47µF
C2307	ECUV1H103KBX	S.M. CAP	50V	10nF
C2308	ECUV1H103KBX	S.M. CAP	50V	10nF
C2353	ECA1CM471GB	ELECT	16V	470µF
C2356	ECA1HM4R7GB	ELECT	50V	4.7µF

Cct Ref	Parts Number	Description		
C2357	ECUV1H151JCX	S.M. CAP	50V	150pF
C2358	ECUV1H151JCX	S.M. CAP	50V	150pF
C2359	ECA1HM4R7GB	ELECT	50V	4.7µF
C2361	ECA1CM470GB	ELECT	16V	47µF
C2362	ECA1HM101GB	ELECT	50V	100µF
C2363	ECEA1HU221	ELECT	50V	100µF
C2364	ECEA1HU221	ELECT	50V	100µF
C2365	ECA1HM101GB	ELECT	50V	100µF
C2366	ECA0JM222GB	ELECT	6.3V	2.2nF
C2367	ECUV1H104ZFX	S.M. CAP	50V	100nF
C2370	ECA1HM100GB	ELECT	50V	10µF
C2371	ECUV1H472KBX	S.M. CAP	50V	4.7nF
C2372	ECUV1H472KBX	S.M. CAP	50V	4.7nF
C2375	ECUV1H104ZFX	S.M. CAP	50V	100nF
C2377	ECKC1H102J	CERAMIC	50V	1nF
C2378	ECKC1H102J	CERAMIC	50V	1nF
C2381	ECKC1H103JB	CERAMIC	50V	10nF
C2382	ECKC1H103JB	CERAMIC	50V	10nF
C2430	ECUV1H561JCX	S.M. CAP	50V	560pF
C2431	ECUV1H561JCX	S.M. CAP	50V	560pF
C2437	ECUV1H561JCX	S.M. CAP	50V	560pF
C2438	ECUV1H561JCX	S.M. CAP	50V	560pF
C3002	ECA1CM470GB	ELECT	16V	47µF
C3003	ECUV1H102ZFX	S.M. CAP	50V	1nF
C3004	ECUV1H104ZFX	S.M. CAP	50V	100nF
C3005	ECUV1H104ZFX	S.M. CAP	50V	100nF
C3006	ECA1HM4R7GB	ELECT	50V	4.7µF
C3007	ECA1HM4R7GB	ELECT	50V	4.7µF
C3008	ECUV1H104ZFX	S.M. CAP	50V	100nF
C3009	ECUV1H473ZFX	S.M. CAP	50V	47nF
C3010	ECUV1H680JCX	S.M. CAP	50V	68pF
C3011	ECA1CM221GB	ELECT	16V	220µF
C3012	ECA1CM470GB	ELECT	16V	47µF
C3013	ECA1CM470GB	ELECT	16V	47µF
C3014	EEUNA1A470B	CERAMIC	10V	47µF
C3015	ECUV1H104ZFX	S.M. CAP	50V	100nF
C3016	ECA1CM470GB	ELECT	16V	47µF
C3017	ECUV1H104ZFX	S.M. CAP	50V	100nF
C3018	ECUV1H104ZFX	S.M. CAP	50V	100nF
C3021	ECA1CM331B	ELECT	16V	330µF
C3022	ECA1CM102B	ELECT	16V	330µF
C3023	ECA1HM100GB	ELECT	50V	10µF
C3024	ECA1HM2R2GB	ELECT	50V	2.2µF
C3025	ECA1CM470GB	ELECT	16V	47µF
C3026	ECUV1H224ZFX	S.M. CAP	50V	220nF
C3027	ECJ2VF1H104Z	ELECT	350V	100nF
C3028	ECUV1H470JRX	S.M. CAP	50V	100nF
C3120	ECUV1H103KBX	S.M. CAP	50V	10nF
C3122	ECUV1H102KBX	S.M. CAP	50V	1nF
C3123	ECUV1H103KBX	S.M. CAP	50V	10nF
C3124	ECUV1H102KBX	S.M. CAP	50V	1nF
C3255	ECA1HM4R7GB	ELECT	50V	4.7µF
C3256	ECA1HM4R7GB	ELECT	50V	4.7µF
C3282	ECKC1H561J	CERAMIC	50V	560pF
C3284	ECKC1H561J	CERAMIC	50V	560pF
C3351	ECA1CM221GB	ELECT	16V	220µF
C3401	ECEA1HKA100	ELECT	50V	220µF
C3402	ECUV1H561JCX	S.M. CAP	50V	560pF
C3403	ECUV1H561JCX	S.M. CAP	50V	560pF
C3404	ECUV1H561JCX	S.M. CAP	50V	560pF
C3405	ECUV1H561JCX	S.M. CAP	50V	560pF
C3406	ECUV1H561JCX	S.M. CAP	50V	560pF
C3407	ECUV1H561JCX	S.M. CAP	50V	560pF
C3408	ECUV1H561JCX	S.M. CAP	50V	560pF
C3409	ECEA1HKA4R7	ELECT	50V	560pF
C3410	ECEA1HKA100	ELECT	50V	560pF

Cct Ref	Parts Number	Description		
C3411	ECUV1H561JCX	S.M. CAP	50V	560pF
C3412	ECEA1HKA4R7	ELECT	50V	560pF
C3413	ECUV1H102JCX	S.M. CAP	50V	1nF
C3414	ECEA1HKA100	ELECT	50V	1nF
C3415	ECEA1HKA100	ELECT	50V	1nF
C3416	ECEA1HKA4R7	ELECT	50V	1nF
C3417	ECEA1HKA100	ELECT	50V	1nF
C3418	ECEA1HKA100	ELECT	50V	1nF
C3419	ECUV1H561JCX	S.M. CAP	50V	560pF
C3420	ECUV1H561JCX	S.M. CAP	50V	560pF
C3421	ECUV1H561JCX	S.M. CAP	50V	560pF
C3422	ECUV1H561JCX	S.M. CAP	50V	560pF
C3423	ECUV1H561JCX	S.M. CAP	50V	560pF
C3424	ECUV1H561JCX	S.M. CAP	50V	560pF
C3425	ECUV1H561JCX	S.M. CAP	50V	560pF
C3426	ECUV1H561JCX	S.M. CAP	50V	560pF
C3427	ECUV1H102JCX	S.M. CAP	50V	1nF
C3428	ECEA1HKA4R7	ELECT	50V	1nF
C3429	ECEA1CKA220	ELECT	16V	1nF
C3430	ECEA1HKA4R7	ELECT	50V	1nF
C3431	ECEA1CN470	ELECT	16V	47µF
C3432	ECUV1H104ZFX	S.M. CAP	50V	100nF
C3433	ECA1CM221GB	ELECT	16V	220µF
C3460	ECUV1H561JCX	S.M. CAP	50V	560pF
C3461	ECUV1H561JCX	S.M. CAP	50V	560pF
C3496	ECUV1H561JCX	S.M. CAP	50V	560pF
C3497	ECUV1H561JCX	S.M. CAP	50V	560pF
C3498	ECUV1H561JCX	S.M. CAP	50V	560pF
C3802	ECA1CM100GB	ELECT	16V	10µF
C3803	ECA1EM100GB	ELECT	25V	0.1µF
C3804	ECUV1H104ZFX	S.M. CAP	50V	100nF
C3805	ECUV1H224ZFX	S.M. CAP	50V	220nF
C3806	ECA1HM101GB	ELECT	50V	100µF
C3807	ECA1HM100GB	ELECT	50V	10µF
C3808	ECA1CM470GB	ELECT	16V	47µF
C3814	ECA1HM010GB	ELECT	50V	1µF
C3816	ECA1CM471GB	ELECT	16V	470µF
C3817	ECA1CM221GB	ELECT	16V	220µF
C3818	ECUV1H103KBX	S.M. CAP	50V	10nF
C3819	ECA1HM010GB	ELECT	50V	1µF
C3821	ECA1HM010GB	ELECT	50V	1µF
C3823	ECUV1H104ZFX	S.M. CAP	50V	100nF
C3824	ECUV1H103KBX	S.M. CAP	50V	10nF
C3825	ECJ2VB1C224K	ELECT	350V	220nF
C3826	ECUV1H103KBX	S.M. CAP	50V	10nF
TERMINALS AND LINKS				
JK2403	TJB8E014	RCA TERMINAL (2P)		
JK3281	TJB16656	A.V. TERMINAL		
JK3401	1364-21-21	SCART SOCKET		
JK3402	1364-21-21	SCART SOCKET		
R847	TSF19252	FS LINK		△
R848	TSF19402	FS LINK		△
SWITCHES				
S840	ESB92S11B	SWITCH		△
S1071	EVQ23405R	SWITCH		
S1072	EVQ23405R	SWITCH		
S1073	EVQ23405R	SWITCH		
S1074	EVQ23405R	SWITCH		
S1075	EVQ23405R	SWITCH		
DIFFERENCES FOR MODEL TX-25AD90F				
MECHANICAL PARTS				
15	TKU8E00280	BACK COVER		△
16	A59ESF002X43	C.R.T.		△

Cct Ref	Parts Number	Description		
17	TKY8E100-3	CABINET		△
18	THE492-4	CRT FIXING SCREW		
19	TNPA1014AL	D P.C.B.		△
20	TLK8E05120	DEGAUSS COIL		△
21	TNPH0176AX	E P.C.B.		△
22	TQF8E2765-1	MODEL LABEL		△
23	TBM8E1726	PANASONIC BADGE		
24	TKP8E1146	SPEAKER NET		
25	TNPA1353AG	Y P.C.B.		△
MISCELLANEOUS COMPONENTS				
	TPC8E4724-1	OUTER CARTON		
	TPD8E619	CUSHION TOP		
	TPD8E626	CUSHION BOTTOM		
I.C.s				
IC451	LA7845N	VERTICAL OUTPUT		
IC1102	X24CWH0503AD	EAROM *		
IC1103	M5M51008BP	SRAM		
TRANSFORMERS				
T551	ZTFM05001A	F.B.T.		△
COILS				
L353	TLT120K991R	COIL		
L363	TLT082K991R	COIL		
L373	TLT120K991R	COIL		
L701	ELC18B331E	COIL		
RESISTORS				
R451	ERDS1TJ2R7	CARBON	0.5W 5%	2R7 Ω
R470	ERJ6GEYJ682	S.M.CARB	0.1W 5%	6K8 Ω
R505	ERDS1TJ2R2	CARBON	0.5W 5%	2R2 Ω
R655	ERJ6GEYJ184	S.M.CARB	0.1W 5%	180K Ω
R702	ERDS1TJ913	CARBON	0.5W 5%	91K Ω
CAPACITORS				
C555	ECWH20392JVY	FILM	200V	39nF
C574	ECWF4564JBB	FILM	400V	560nF
C575	ECWF4684JBB	FILM	400V	680nF
DIFFERENCES FOR MODEL TX-29AD90F				
MECHANICAL PARTS				
15	TKU8E00270	BACK COVER		△
16	A68EHM69X83	C.R.T.		△
17	TKY8E081	CABINET		△
18	THT1009R	CRT FIXING SCREW		
19	TNPA1014AM	D P.C.B.		△
20	TLK8E05135	DEGAUSS COIL		△
21	TNPH0176AY	E P.C.B.		△
22	TQF8E2760-1	MODEL LABEL		△
23	TBM8E1728	PANASONIC BADGE		
24	TKP8E1144	SPEAKER NET		
25	TNPA1353AH	Y P.C.B.		△
MISCELLANEOUS COMPONENTS				
	TBM8E1901-1	AV LABEL		
	TPC8E4734	OUTER CARTON		
	TPD8E617-2	CUSHION TOP		
	TPD8E618	CUSHION BOTTOM		
I.C.s				
IC451	LA7876	VERTICAL OUTPUT		
IC1102	X24CWH0502BD	EAROM *		
IC1103	KM681000CLP	SRAM		
DIODES				
C403	MA165TA5	DIODE		
D403	EU02AV0	DIODE		

Cct Ref	Parts Number	Description			
TRANSFORMERS					
T551	ZTFM05005A	F.B.T.			⚠
COILS					
L353	TLT150K991R	COIL			
L363	TLT100K991R	COIL			
L373	TLT150K991R	COIL			
L701	ELC18B271E	COIL			
RESISTORS					
R443	ERJ6GEYJ822	S.M.CARB	0.1W	5%	8K2 Ω
R451	ERDS1TJ3R3	CARBON	0.5W	5%	3R3 Ω
R470	ERJ6GEYJ183	S.M.CARB	0.1W	5%	18K Ω
R655	ERJ6GEYJ224	S.M.CARB	0.1W	5%	220K Ω
R702	ERDS1TJ683	CARBON	0.5W	5%	68K Ω
CAPACITORS					
C401	ECA1VM102GB	ELECT	35V		1nF
C555	ECWH20432JVY	FILM	200V		4.3nF
C574	ECWF4684JBB	FILM	400V		680nF
C575	ECWF4564JBB	FILM	400V		560nF

Cct Ref	Parts Number	Description
---------	--------------	-------------

SCHEMA ELETTRICO TX-29AD90F TX-25AD90F (TELAIO EURO-5)

IMPORTANTI INFORMAZIONI DI SICUREZZA

I componenti indicati con  hanno caratteristiche speciali ed importante per la sicurezza. Qualora tali componenti vengano sostituiti, devono essere usati solo quelli specificati dal costruttore.

Nota

1. RESISTENZE

Tutte le resistenze sono al carbone da 1/8W se sono contrassegnate come segue :
I valori sono espressi in OHM Ω k=1,000 M= 1,000,000.

2. CONDENSATORI

Tutti i condensatori sono ceramici 50V, se non sono contrassegnati come segue :
I valori sono espressi in μ F, se non diversamente specificato.

3. BOBINE

I valori sono espressi in μ H, se non diversamente specificato.
Il contrassegno "L" sullo schema elettrico indica la polarità.

4. TEST POINT



Posizione dei test point

5. MASSA



Massa Linea (Caldo)



Massa Telaio (Freddo)

6. CONTROLLI DI TENSIONE

Le tensioni sono misurate con voltmetro d.c. alle seguenti condizioni :

Alimentazione	a.c. 220-240V, 50Hz
Segnale ricevuto	Segnale a barre colori in (RF)
Controlli dell'utente	Massime regolazioni

7. Indica il flusso di segnale principale.



VIDEO



AUDIO

8. Questo schema elettrico è soggetto a variazioni senza preavviso.

Precauzioni

- Nell' intendo di prevenire possibili scosse elettriche evitare di toccare le zone fredde e calde.
- Un corto circuito fra le due sezioni può provocare anomalie nei componenti.
- Nell' utilizzo di uno strumento di misura la massa dello stesso deve essere collegata alla massa del circuito da misurare.
- Le resistenze sotto indicate sono componenti fusibili di sicurezza, e risultano differenziati per valori di corrente.

Nota

- Nel circuito di alimentazione è presente una sezione le cui tensioni risultano separate dalla massa generale del telaio. Sullo schema elettrico vengono definite aree calda e fredda. Prestare particolare attenzione. Tutti i circuiti escluso quella di alimentazione sono freddi.

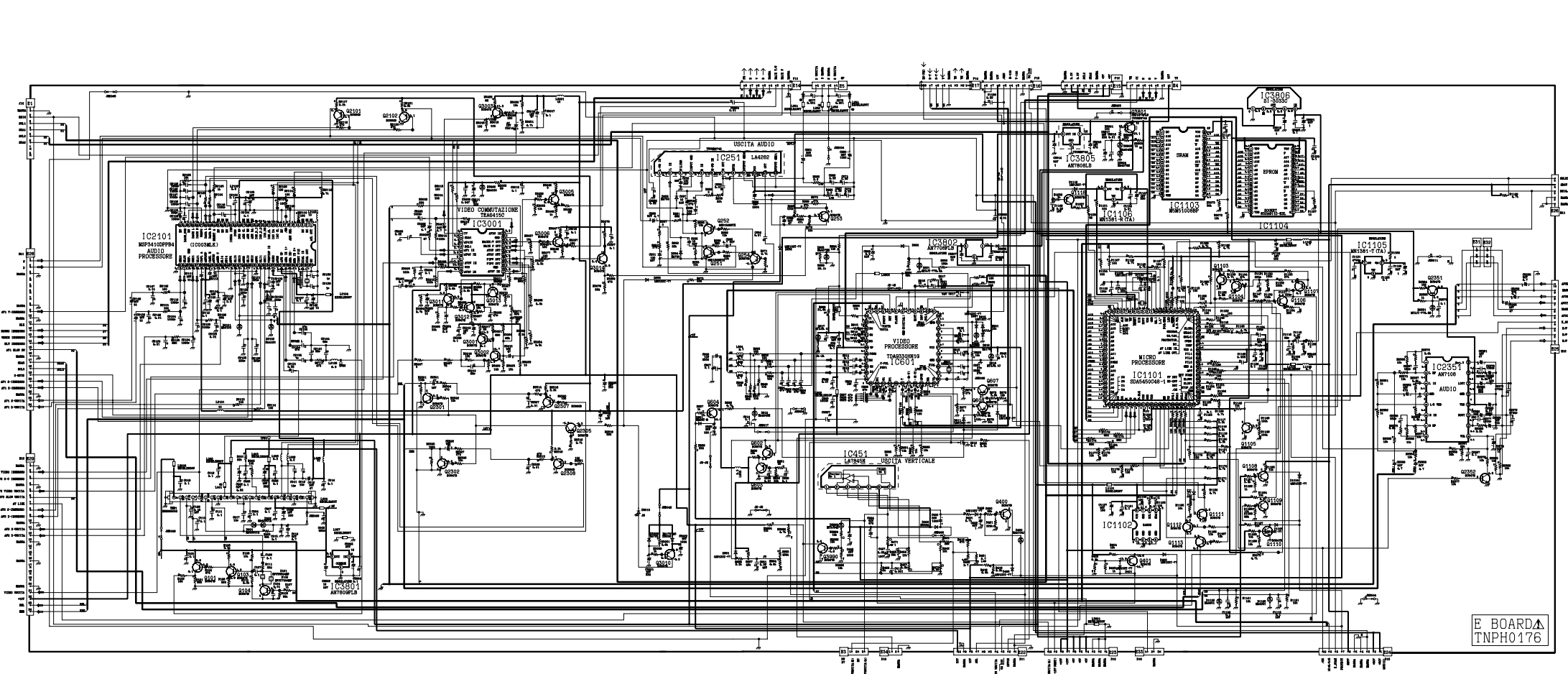

E BOARD
TNP0176

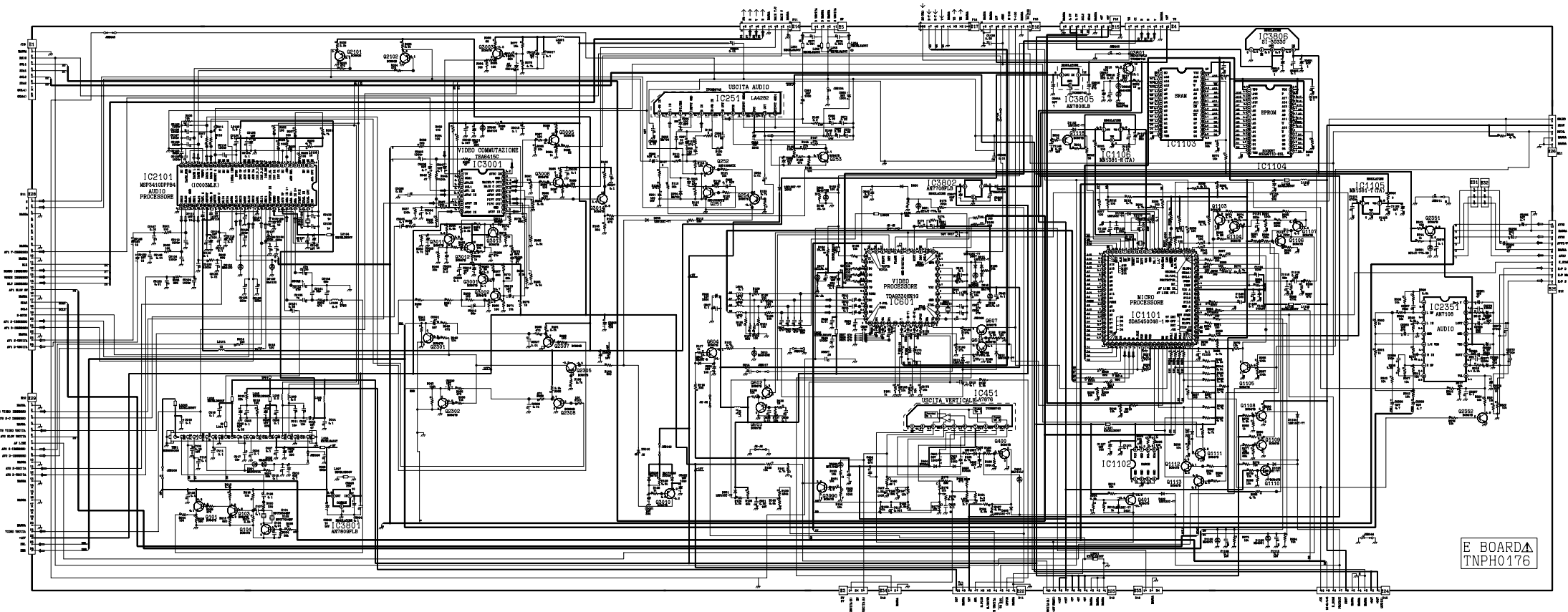

E BOARD
TNP0176

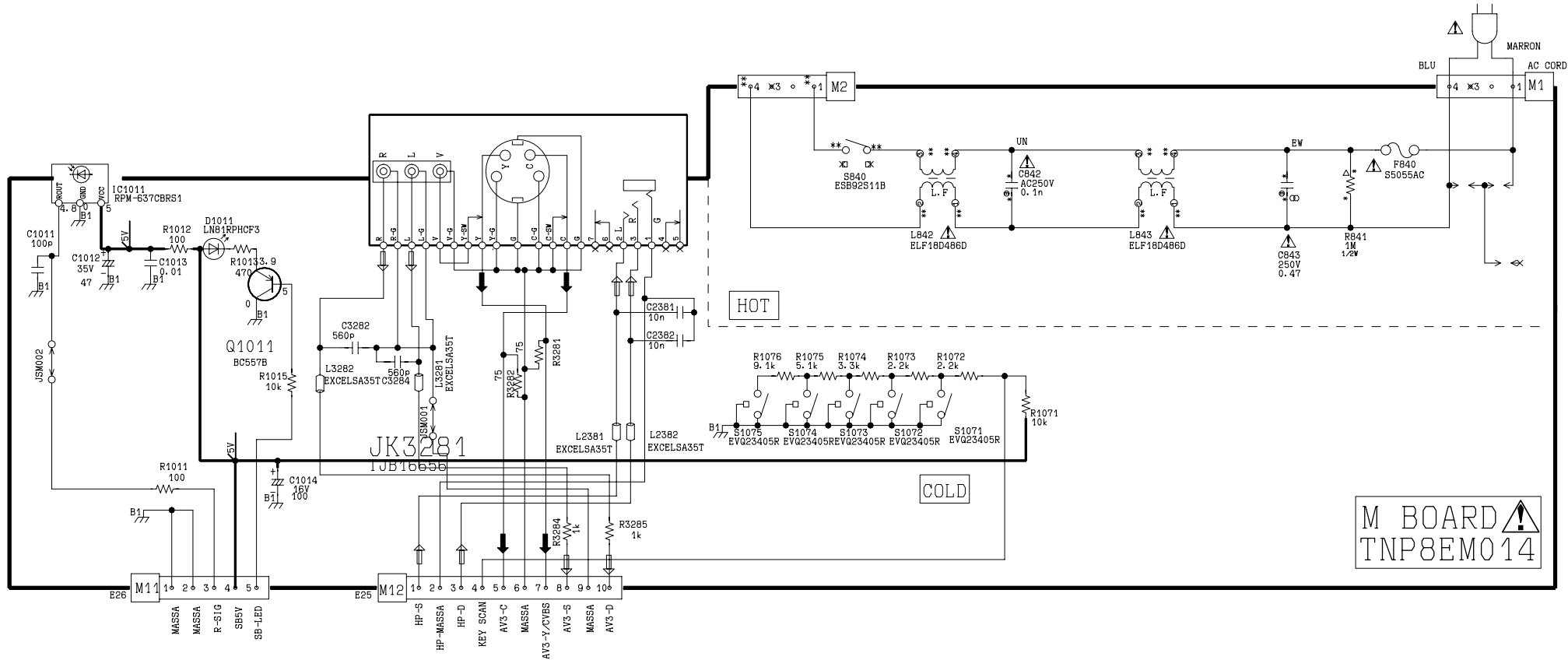

H BOARD
TNPA1047

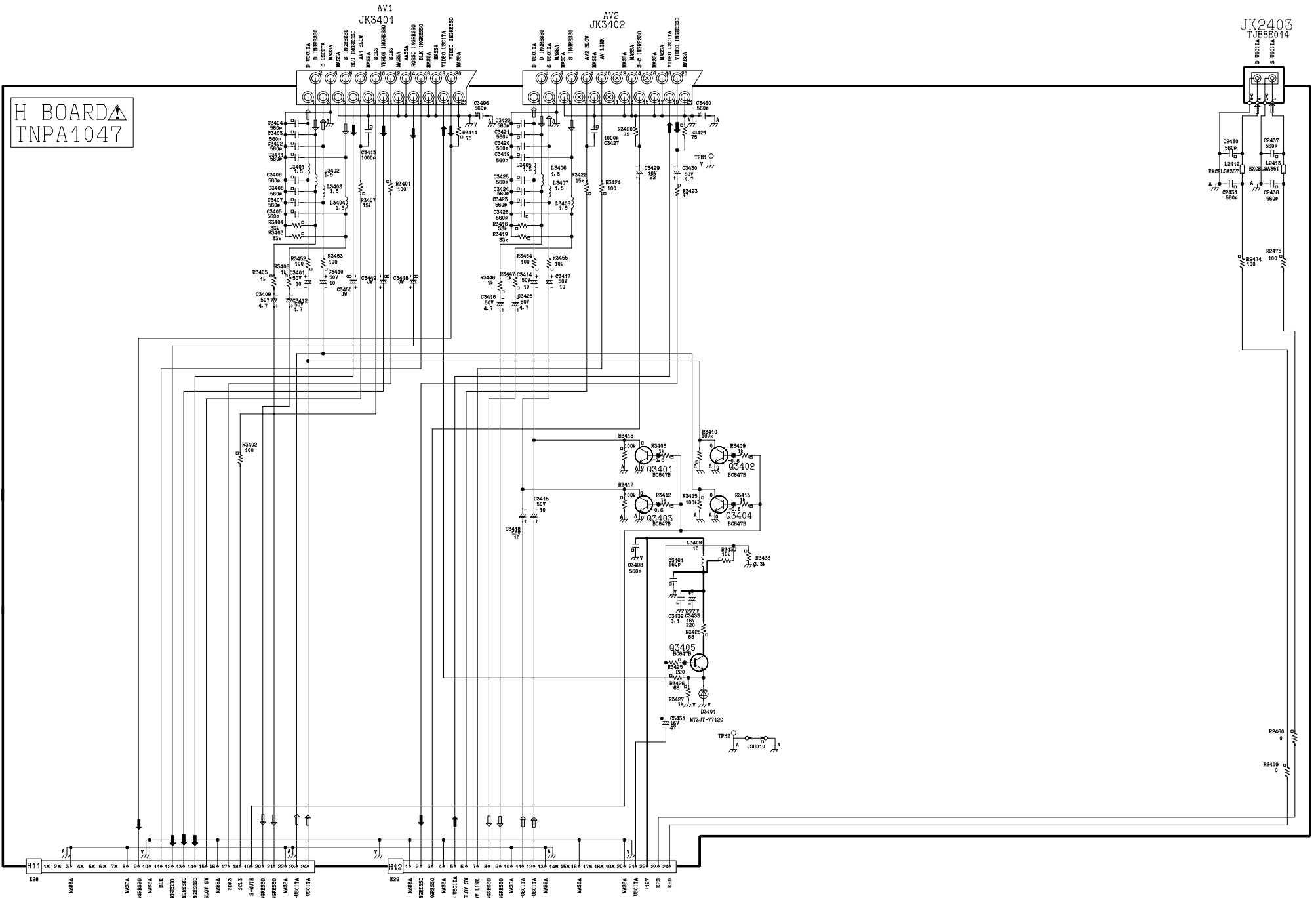

JUB8E014

J8010

B28

B29

F BOARD ▲
TNPA1068

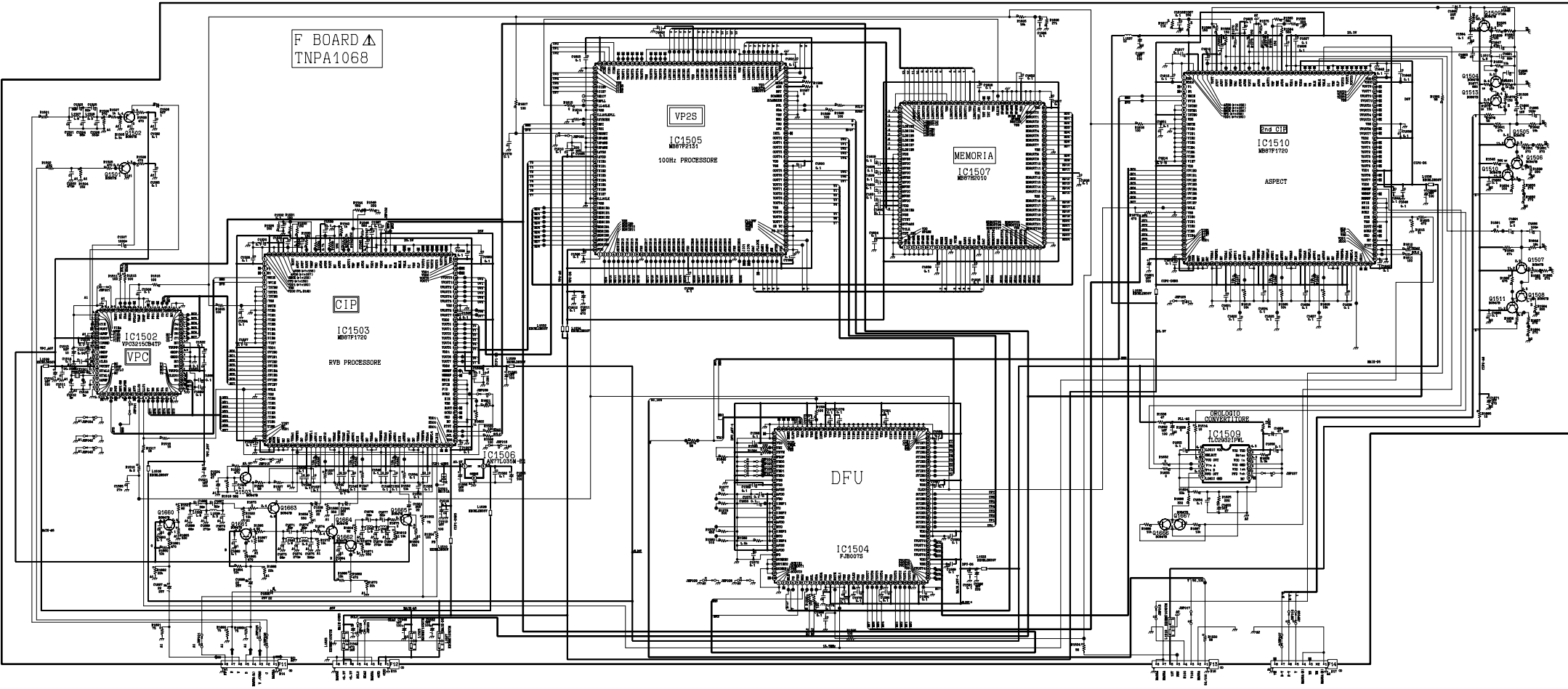

Y BOARD

TNPA1353

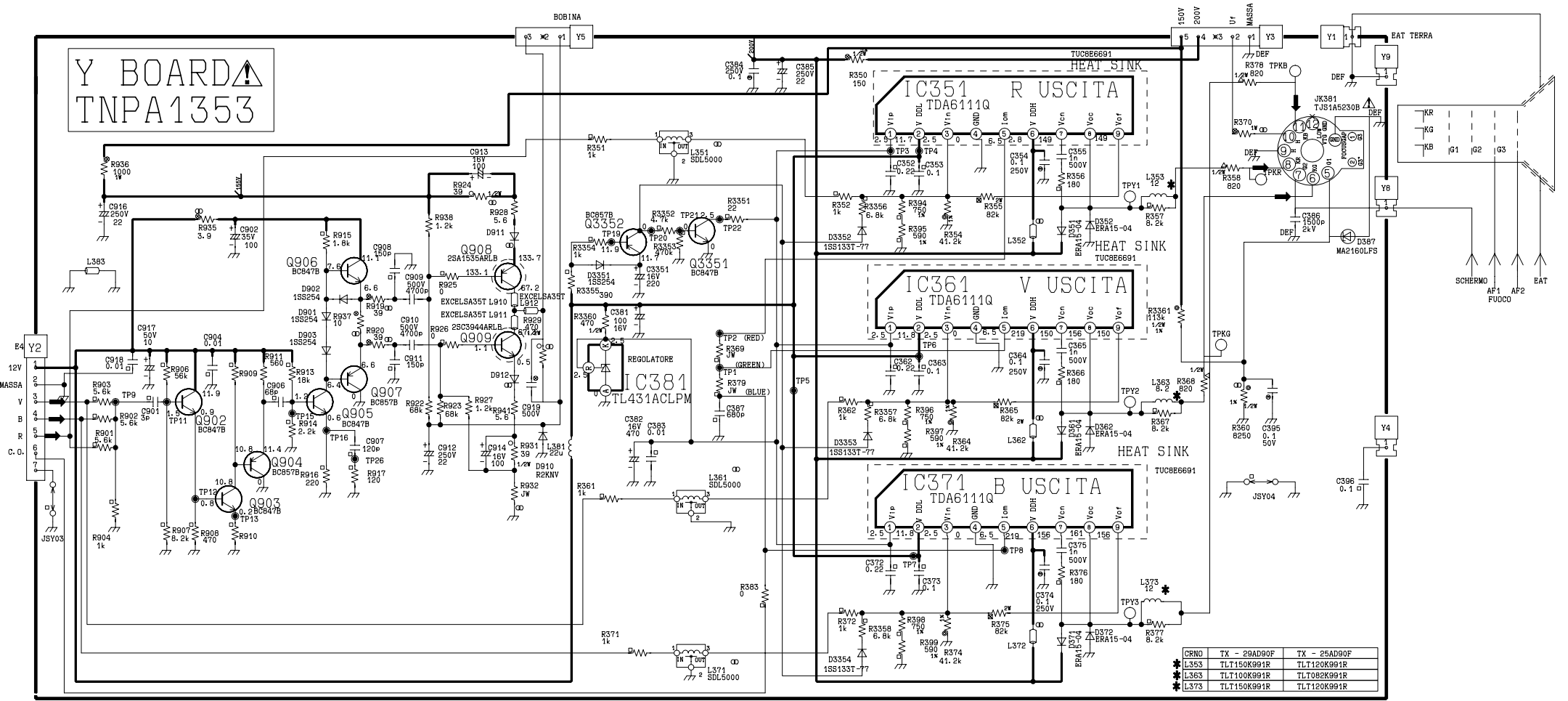

CRNO	TX - 29AD90F	TX - 25AD90F
L353	TL1150K991R	TL120K991R
L363	TL1100K991R	TL1082K991R
L373	TL1150K991R	TL120K991R

SCHEDA - Y TNPA1353

TRAN'S	
Q901	C1
Q902	B1
Q903	B1
Q904	C1
Q906	C1
Q908	D1
Q909	D1
Q3351	A2
Q3352	A2
DIODE'S	
D351	B3
D352	B3
D361	A2
D362	A2
D371	C3
D372	C2
D373	C3
D374	A1
D375	B2
D387	B1
D901	C1
D902	C1
D903	C1
D910	C1
D911	D2
D3351	A2
D3352	A3
D3353	A1
D3354	C3
T.P.'S	
TPY1	B3
TPY2	A2
TPY3	C2
TPKR	B3
TPKG	B2
TPKB	C2
I.C.'S	
IC351	B2
IC361	A1
IC371	C3
IC381	C3

A

B

C

D

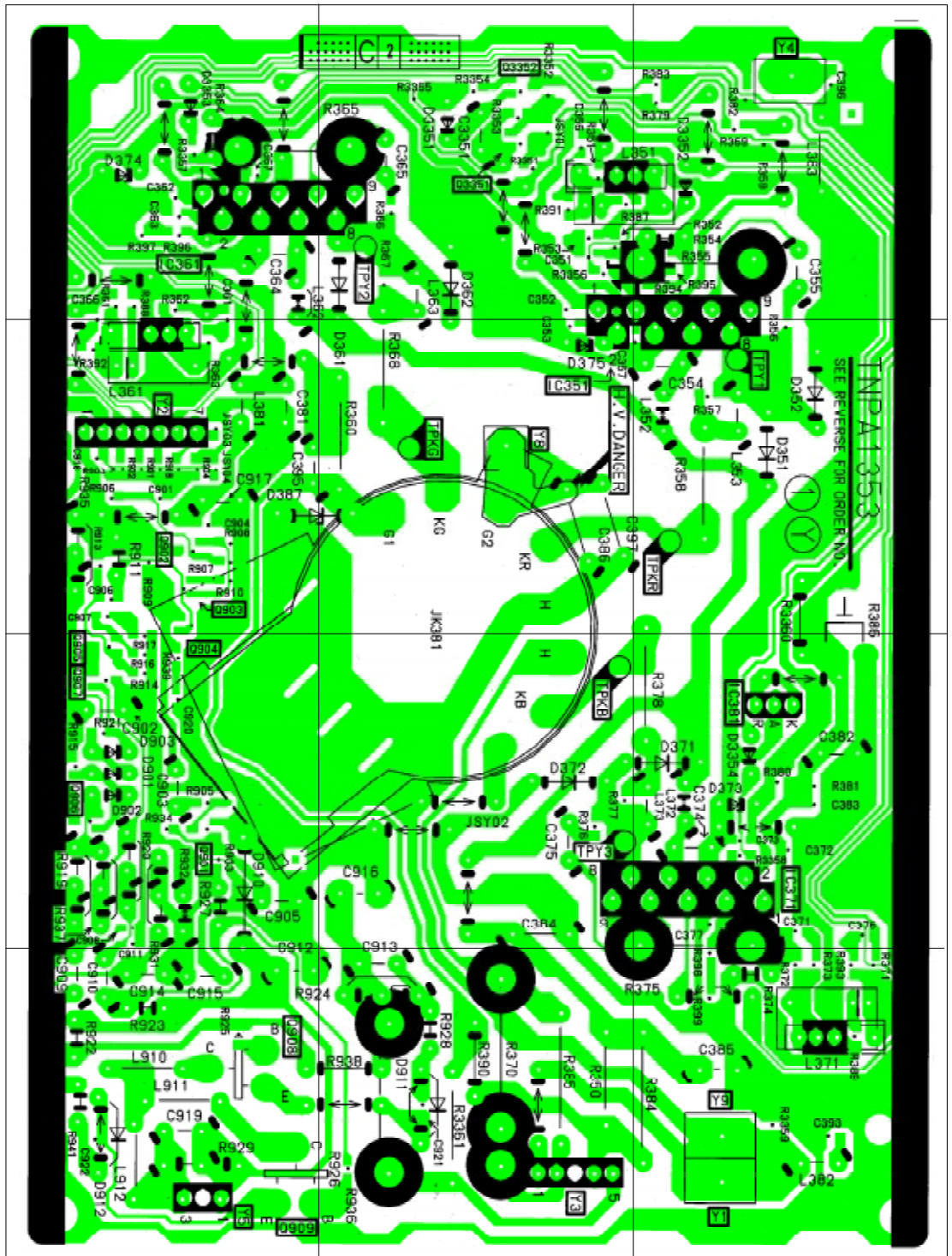

1

2

3

VISTA LATO COMPONENTI

SCHEDA - E TNPH0176

TRAN'S		DIODE'S		
Q101	A3	D001	A1	D2364 A6
Q103	A3	D002	A1	D3005 B1
Q104	A3	D252	E5	D3006 B2
Q251	D4	D253	E5	D3008 B4
Q252	D4	D254	E5	D3009 A3
Q253	E4	D255	E4	D3010 A3
Q254	E4	D256	E4	D3011 B1
Q281	E3	D281	E4	D3803 A5
Q282	D3	D282	E4	D3804 A5
Q400	B5	D283	E4	D3805 C5
Q401	A4	D284	E2	D3990 A4
Q601	B5	D285	E3	
Q602	B4	D286	E2	I.C.'S
Q603	C4	D400	B5	IC251 E4
Q604	C4	D401	A4	IC281 E2
Q607	C4	D402	A4	IC451 A4
Q608	D4	D403	B4	IC601 C4
Q1001	C7	D404	A4	IC1001 C7
Q1105	C6	D405	A6	IC1101 D5
Q1106	C6	D408	B5	IC1102 E5
Q1107	C6	D411	A4	IC1103 E5
Q1108	A5	D601	B4	IC1104 D5
Q1109	A5	D603	D5	IC1105 B6
Q1110	A5	D605	B5	IC1106 D6
Q1111	C5	D607	B5	IC1901 C6
Q1112	E5	D609	B5	IC2101 B3
Q1113	E5	D610	C4	IC2351 A6
Q1114	C6	D611	C4	IC3001 B1
Q1116	C6	D612	C4	IC3801 A2
Q1118	D6	D615	B5	IC3802 C5
Q1901	C6	D616	B5	IC3805 B5
Q2101	B2	D617	D5	IC3806 D1
Q2102	C2	D618	C4	
Q2103	B2	D620	B5	T.P.'S
Q2301	B2	D651	C4	TPE1 A2
Q2302	A2	D652	C4	TPE2 B3
Q2305	A2	D653	B4	TPE23 D6
Q2307	A3	D1001	C7	
Q2308	A3	D1101	C1	
Q2351	A6	D1102	C1	
Q2352	A6	D1103	C1	
Q3001	C1	D1104	A6	
Q3002	B1	D1105	A6	
Q3003	B2	D1106	B6	
Q3005	D1	D1107	C5	
Q3006	D1	D1108	C6	
Q3007	D1	D1109	D6	
Q3008	D1	D1110	D6	
Q3010	A3	D1111	D6	
Q3011	B2	D1112	D6	
Q3012	B2	D2101	B2	
Q3013	B2	D2102	B2	
Q3014	D1	D2301	A2	
Q3801	A5	D2302	A2	
Q3990	A4	D2351	A6	

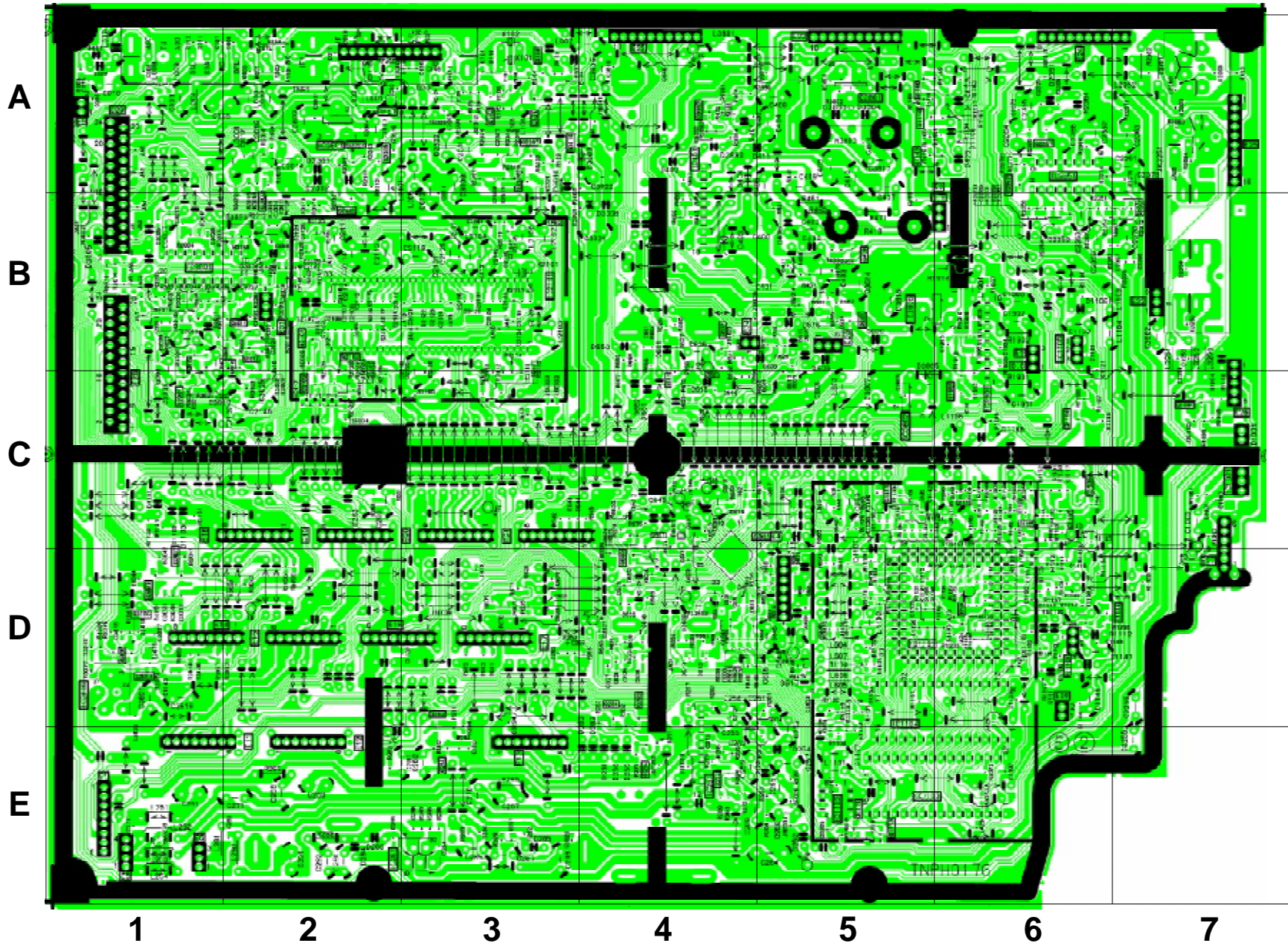

SCHEDA - D TNPA1014

DIODE'S	TRAN'S
D503	A4
D504	A3
D505	C3
D551	A4
D556	C1
D559	E3
D560	D1
D561	D1
D563	A3
D565	A1
D566	A1
D571	A2
D575	C1
D701	E2
D803	C4
D807	B6
D808	B4
D809	B4
D810	B4
D812	B4
D813	B4
D814	C4
D815	C3
D817	C6
D818	B4
D819	B4
D820	C4
D821	C4
D845	D7
D846	D7
D847	E6
D848	E5
D849	E5
D850	E4
D851	D3
D852	D3
D853	E7
D854	E6
D855	E3
D856	E7
D857	E3
D858	E5
D860	E1
D861	E7
	I.C.'S
	IC801 B4
	IC845 D3
	IC852 E2
	T.P.'S
	TPDG1 D1
	TPDG2 D1

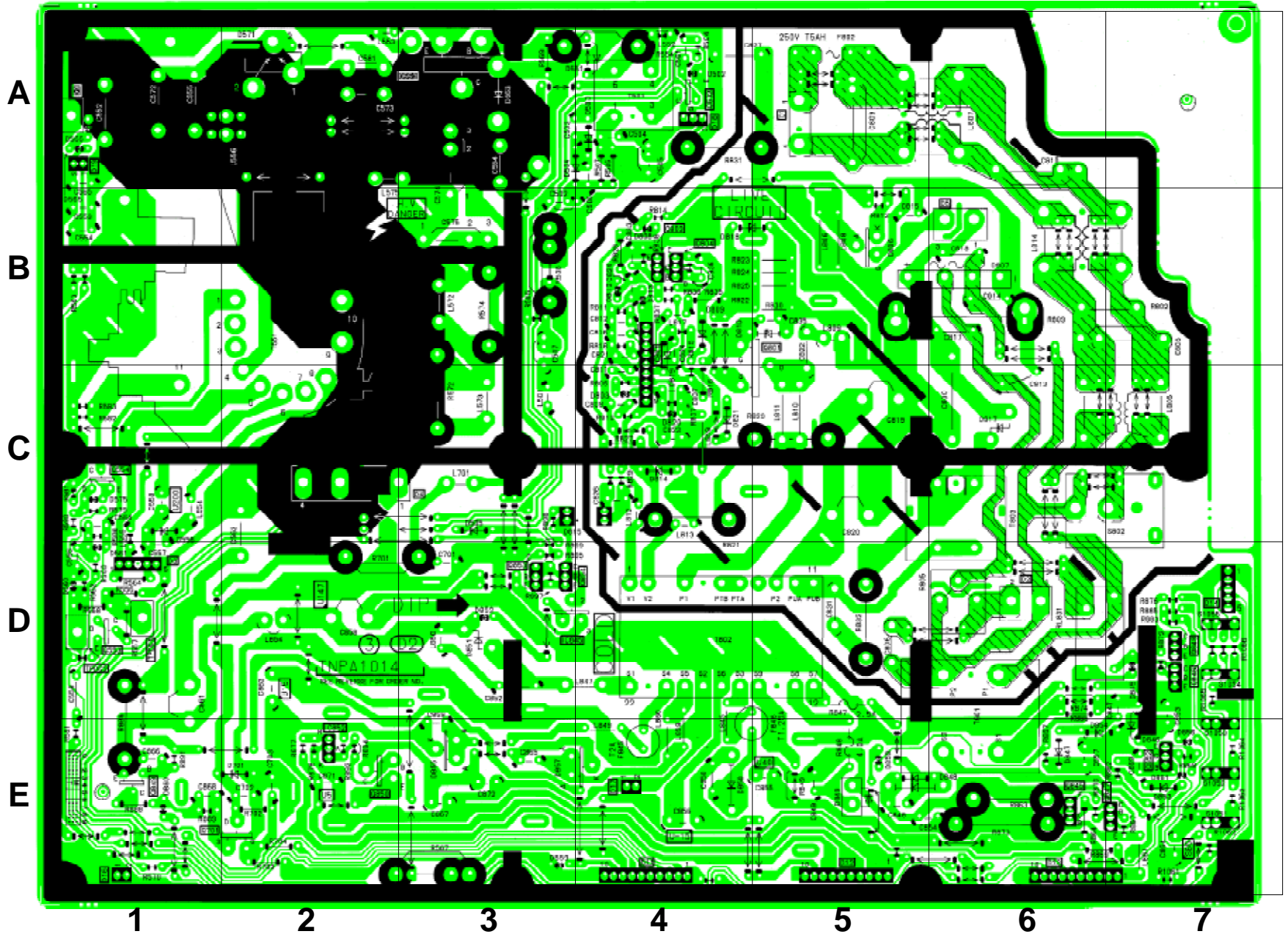

SCHEDA - H TNPA1047

TRAN'S	
Q2401	A2
Q2407	A3
Q2408	A3
Q2409	A3
Q2410	A3
Q2411	A3
Q2412	A3
Q3401	B1
Q3402	C1
Q3403	B1
Q3404	C1
Q3405	C3
Q3406	C3

DIODE'S	
D2401	A2
D2403	A3
D2404	A3
D2405	A3
D2406	A3
D2407	A3
D2408	A3
D3401	C3
D3402	C3

T.P.'S	
TPH1	D1
TPH2	A2
TPH3	D1
TPH004	D1
TPH005	D1

I.C.'S	
IC2401	A2
IC2402	A3

A

B

C

D

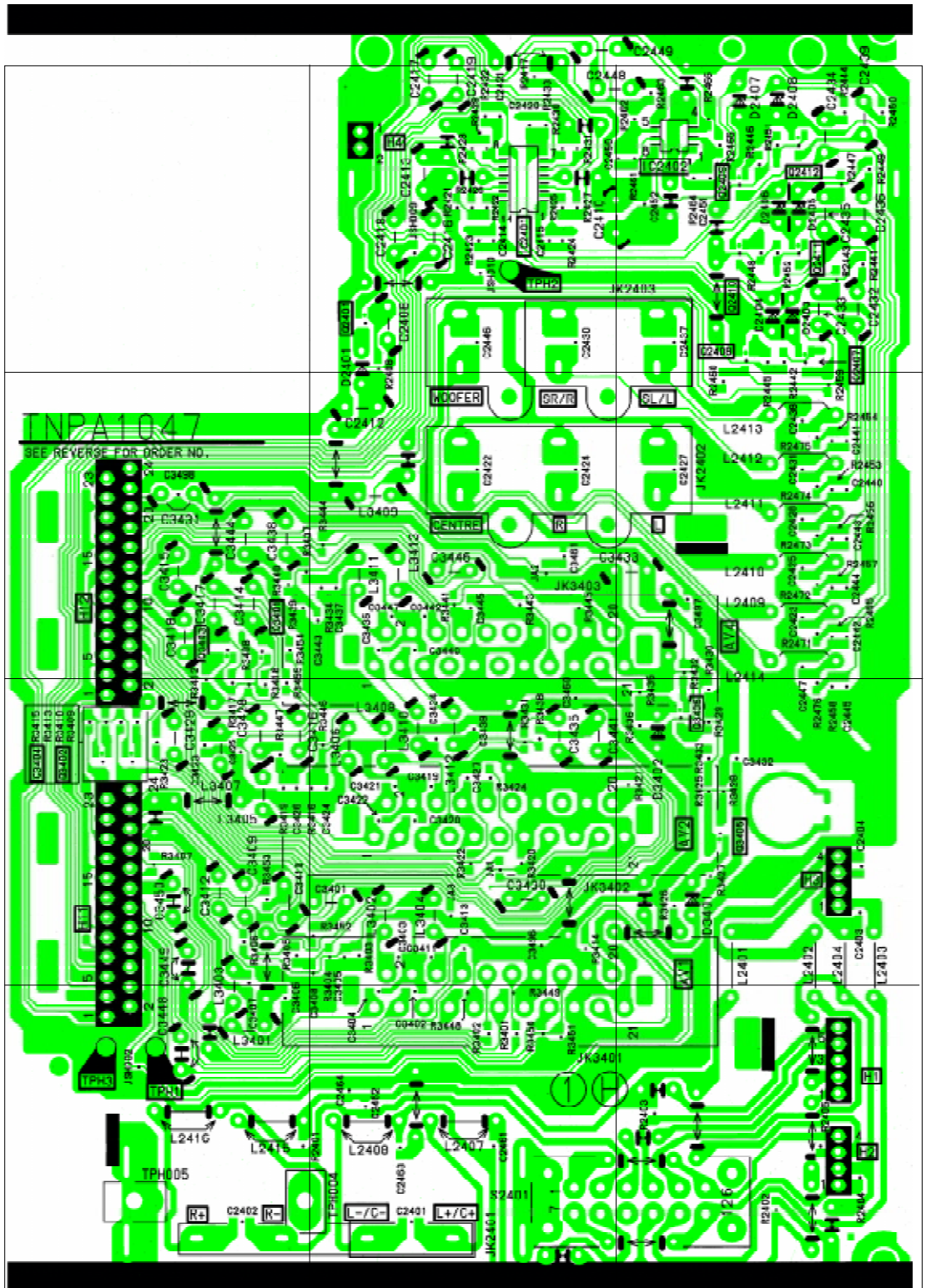

1

2

3

SCHEDA - M TNP8E014

TRAN'S	
Q1011	A1
Q1012	A2
DIODE'S	
D1011	A1
I.C.'S	
IC1011	A1

A

B

C

D

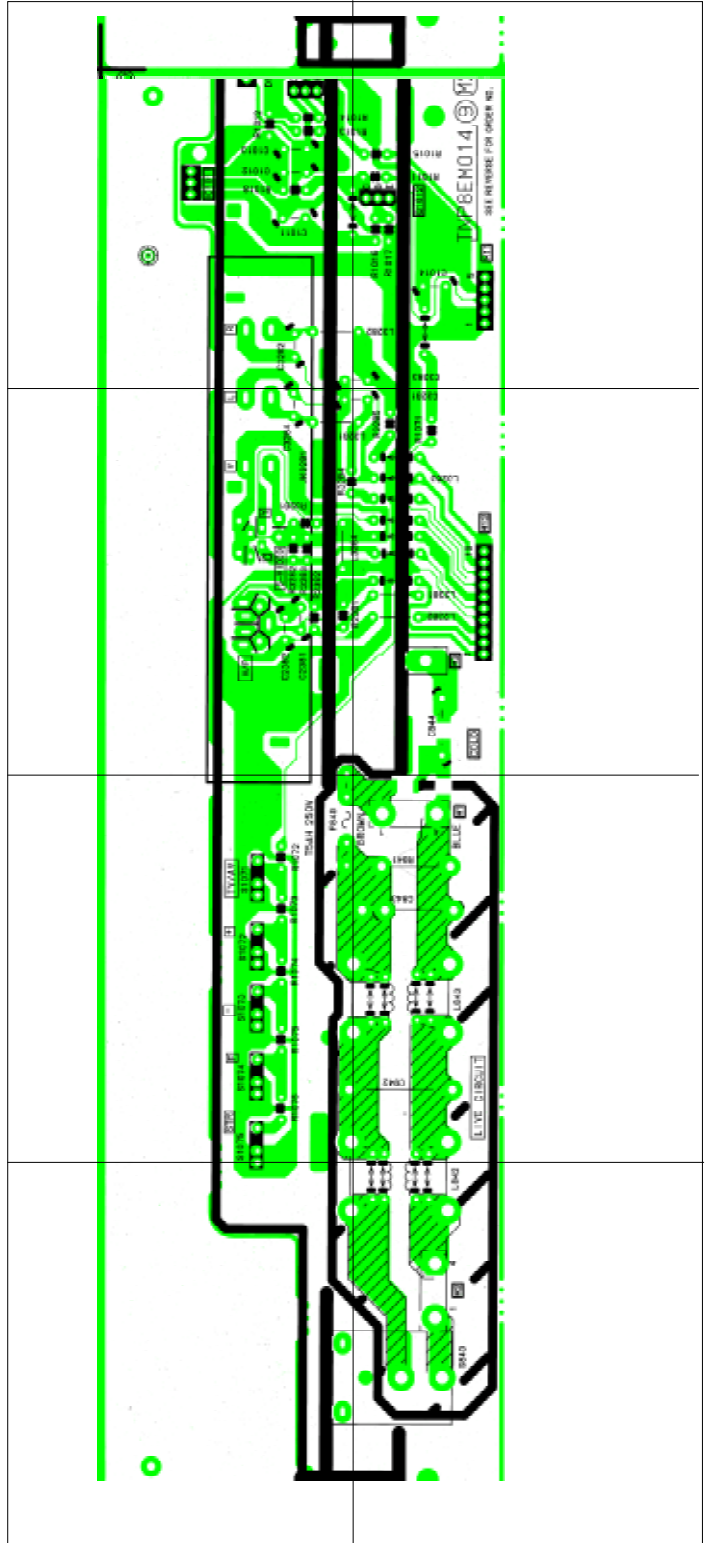

1

2

SCHEDA - F TNPA1068

TRAN'S	
Q1663	B2
Q1664	B2
Q1665	B2
Q1666	C1
Q1667	C1
I.C.'S	
IC1502	B3
IC1503	C3
IC1504	D1
IC1505	D2
IC1506	C2
IC1509	C1
IC1510	C1

A

B

C

D

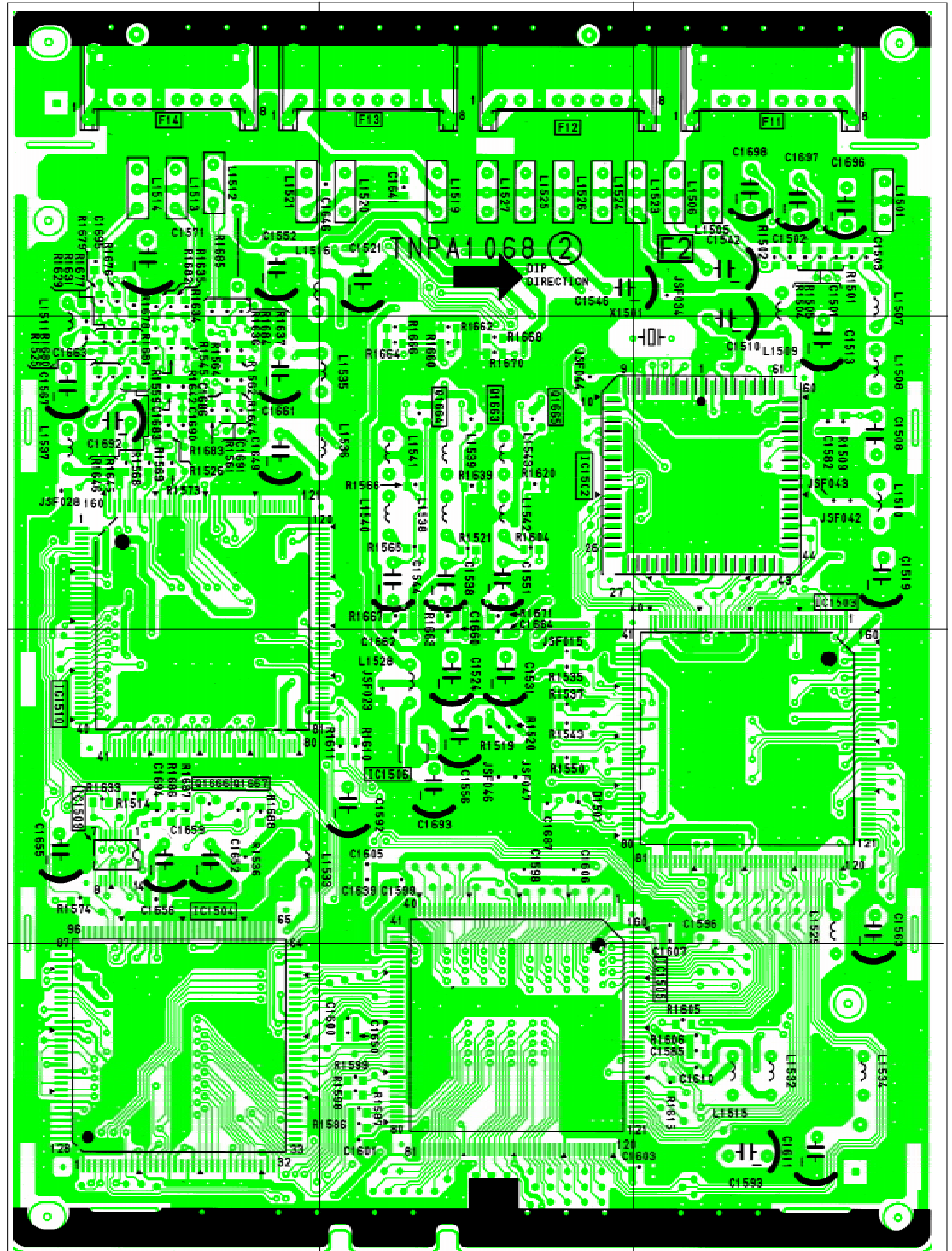

1

2

3

